

LESSON 5.

METHODS

REVIEW

- Organization of cerebral cortex: historical perspective on functional localization.
- Maps organize the first level of cortical processing and condition learning.
- Transduction is the process of converting external physical energy into neuronal language of sensory system. Specialized receptors, acoustic as example.
- Tactile receptors (SA and RA), temperature, nociceptors. Pain as a nociceptor pathway, but strongly modulated by conditions; placebo.

OUR AIM: computational cognitive neuroscience of sensation and perception

... all that we have seen until now basic background leading towards the golden triangle

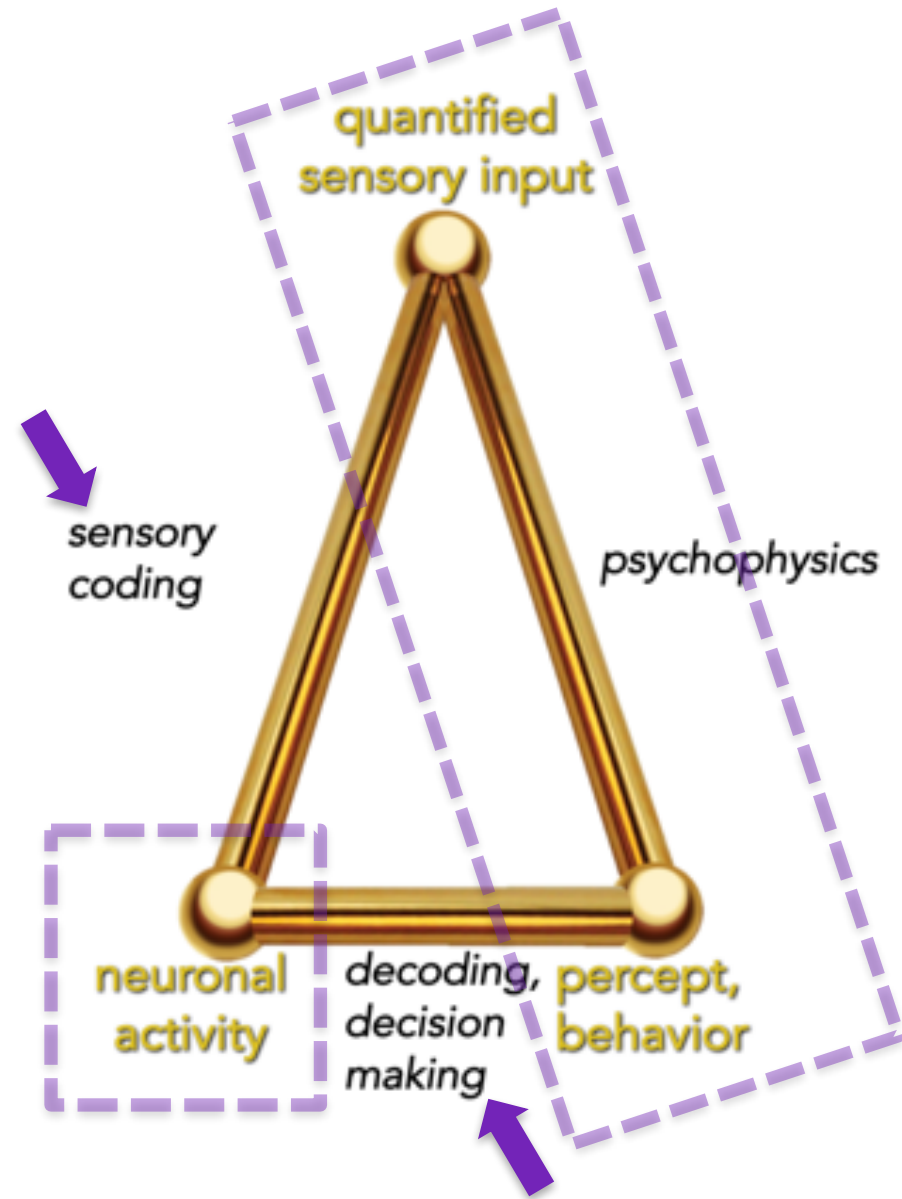

 psychophysics

measuring neuronal activity

building an apparatus

monitoring behavior

Psychophysics

- Gustav Fechner (1801-1887), German physicist and psychologist, invented "psychophysics": the science of measuring the mind.
- Pp uncovers relation between quantitative variables and qualitative (subjective) experience: physics of "mental energy" akin to the successful physics of physical energy which was being developed in the 19th century.
- The raw materials are of two kinds:
 1. independent variables (e.g., light, sound, or mechanical pressure), and dependent variables
 2. behavioral responses of various kinds, such as vocalizations (e.g., "I saw it") or button presses.

- Question that provides an introduction to Pp:
How **sensitive** is a sensory system?
- This is determined by measuring the amplitude of a particular stimulus required to reliably detect that stimulus – **the threshold**.
- **sensory threshold** is “the doorway” ... the entrance a stimulus must pass through to reach perceptual awareness. For instance, the threshold for a particular light stimulus is the minimal intensity at which it is “just barely seen”.

psychophysical methods

Methods of Limits:

Subject indicates on each trial (on each presentation) whether the stimulus was "seen" or "not seen" (or felt, or heard, or smelled, etc.).

Results go into a table (next slide).

	Stimulus #	Trial #1	Trial #2	Trial #3	Trial #4	% "Yes" Responses
Increasing Stimulus Intensity →	S1	N	N	N	N	0/4 (0%)
	S2	N	N	N	N	0/4 (0%)
	S3	N	N	N	N	0/4 (0%)
	S4	N	N	N	N	0/4 (0%)
	S5	N	N	N	N	0/4 (0%)
	S6	Y	N	N	N	1/4 (25%)
	S7	Y	N	Y	N	2/4 (50%)
	S8	Y	N	Y	Y	3/4 (75%)
	S9	Y	Y	Y	Y	4/4 (100%)
	S10	Y	Y	Y	Y	4/4 (100%)
	S11	Y	Y	Y	Y	4/4 (100%)
	S12	Y	Y	Y	Y	4/4 (100%)

Stimulus reported as seen (Y, green) or not seen (N, red) on each presentation.

Here we see **ascending** series. In each column there is a discrete intensity at which the stimulus appears to cross a threshold from unseen ("No" response) to seen ("Yes" response).

But ascending/descending series are predictable to subject. Thus neuroscientists nowadays almost always use random stimulus presentation rather than ascending (or descending) series.

	Stimulus #	Trial #1	Trial #2	Trial #3	Trial #4	% "Yes" Responses
Increasing Stimulus Intensity ↑	S1	N	N	N	N	0/4 (0%)
	S2	N	N	N	N	0/4 (0%)
	S3	N	N	N	N	0/4 (0%)
	S4	N	N	N	N	0/4 (0%)
	S5	N	N	N	N	0/4 (0%)
	S6	Y	N	N	N	1/4 (25%)
	S7	Y	N	Y	N	2/4 (50%)
	S8	Y	N	Y	Y	3/4 (75%)
	S9	Y	Y	Y	Y	4/4 (100%)
	S10	Y	Y	Y	Y	4/4 (100%)
	S11	Y	Y	Y	Y	4/4 (100%)
	S12	Y	Y	Y	Y	4/4 (100%)

The value of threshold varies from column to column (trial to trial):
 threshold must not be a fixed, unchanging point along the sensory continuum.

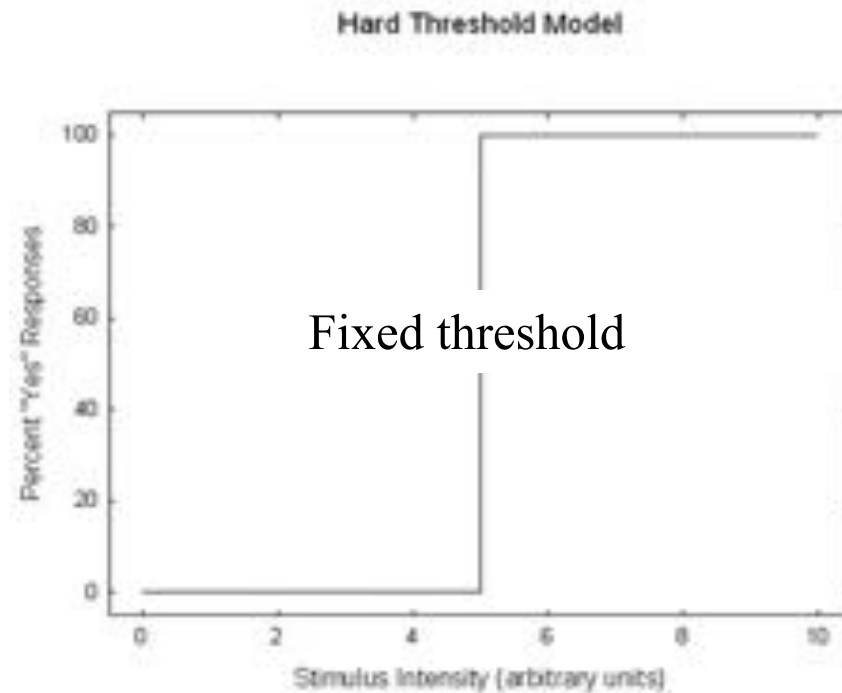

Fixed threshold? No. Thresholds are stochastic (that is, probabilistic, or variable):

- threshold changes over time (general level of neural excitability changes),
and/or
- variable amount of "noise" in detecting mechanisms on different series of trials.

In reality, threshold is a probability that a (Y) response will be given.

Stochastic Threshold Model

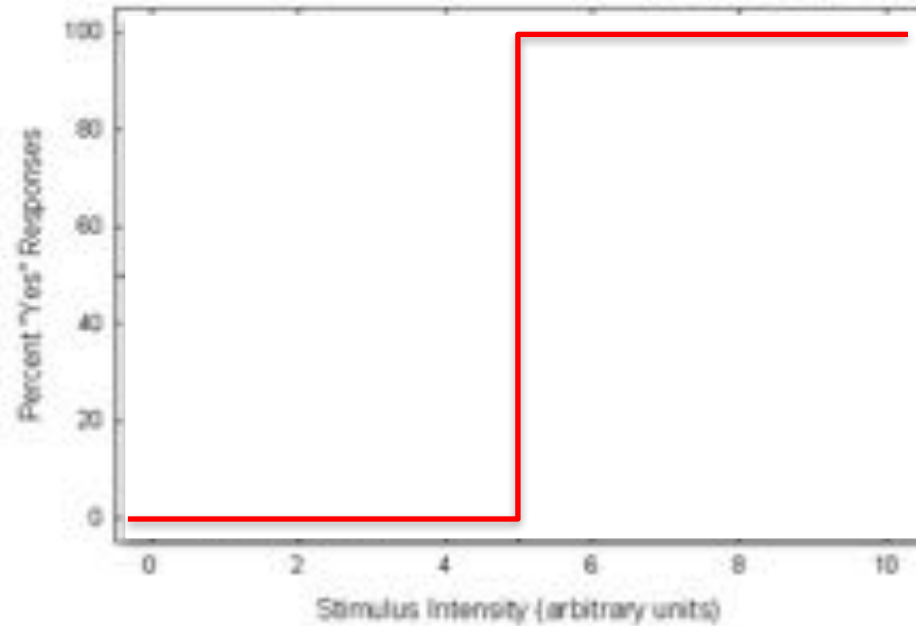

- Graphs which plot a behavioral response (here % "Yes") as a function of a physical variable (i.e., stimulus intensity) are psychometric functions.
- Curve through the data points is the best fit to a **cumulative normal distribution**: the integral of a normal distribution.

Stochastic Threshold Model

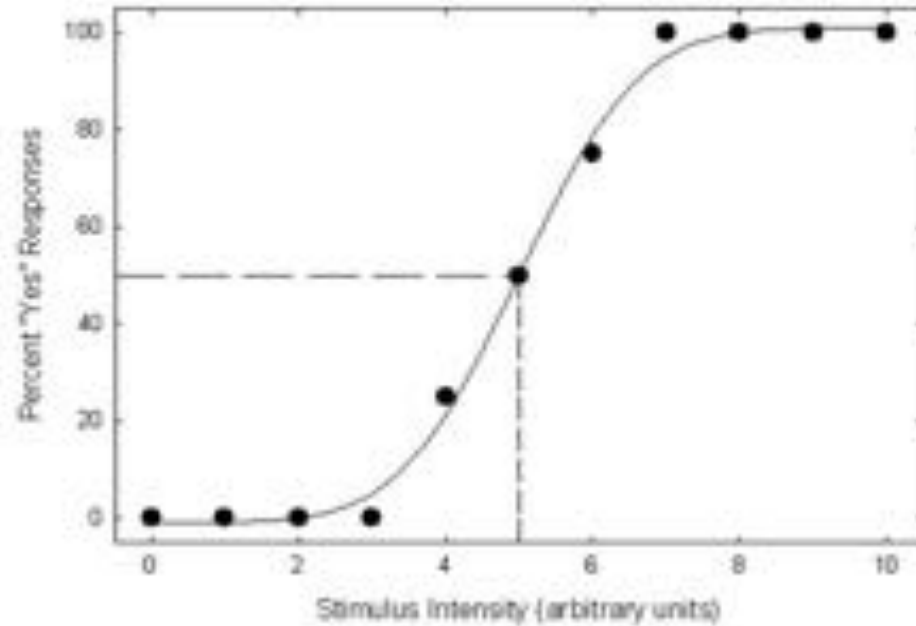

- We usually called them *sigmoid* functions.
- If threshold defined as 50% "Yes" response rate, follow 50% horizontally, find intersection, then follow the short dashed vertical line down to the abscissa. Here, 5 units would be defined as the threshold for this stimulus.

calculation of the brain is on \hat{s} : comparison between \hat{s} and a “fixed” reference: “ r ”

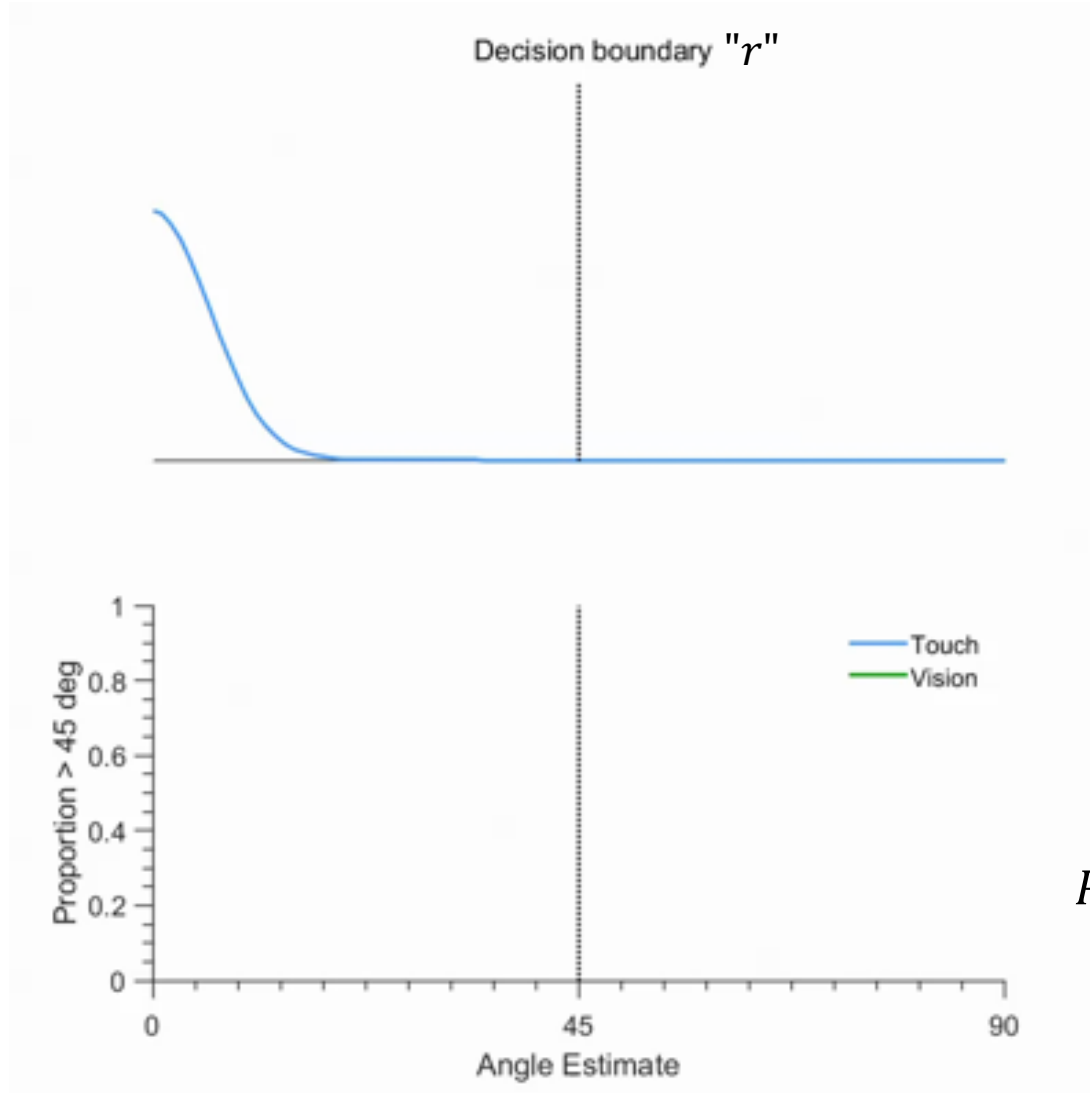

$$P(s \geq r) \equiv CDF(\hat{s}) = \int_r^{\infty} P(s) ds$$

- **Serious flaw**: the point at which "No" responses become "Yes" responses might depend on the whim of the subject. No control over the **response criterion** for stating whether a stimulus was detected or not.
- Some subjects may be cautious and refrain from saying "Yes" until the stimulus is clearly visible to them. Others are risk-takers, saying "Yes" even if they're not entirely sure - perhaps they want to demonstrate that they are expert in perceiving a tiny stimulus.
- Role of Instructions to Subjects.
- Subjects may respond how they think the experimenter wants them to respond.
- Subjects may even change response criteria within the course of an experiment.

«Do you see it or not?»

For the moment, forget the laboratory and think of real-life situations in which a person needs to say whether they detect a stimulus or not.

Do the circumstances affect their responses?

OF COURSE!



Forced-Choice

- Circumvents the problem of response criteria.
- Subjects are presented with two or more potential stimuli, and must select one on each trial. The choice can thus be coded as a criterion-free "correct" or "incorrect". Alternatives can be presented sequentially (temporal forced-choice), or can be presented simultaneously (spatial forced-choice).
- There must be at least 2 alternatives -- there can be up to 4 or 5. (confusing however).
- Next figure 2-alternative forced-choice task detection task.

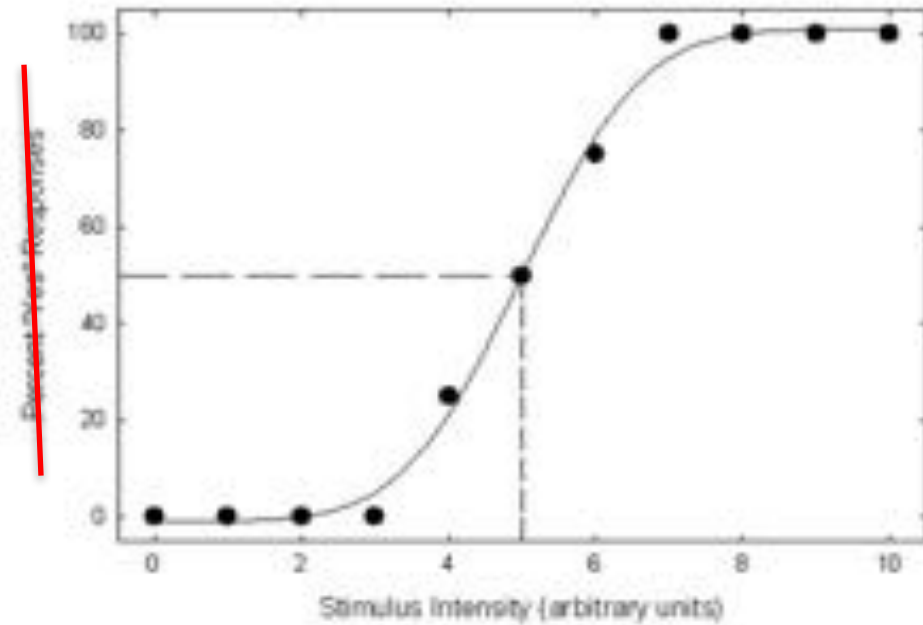
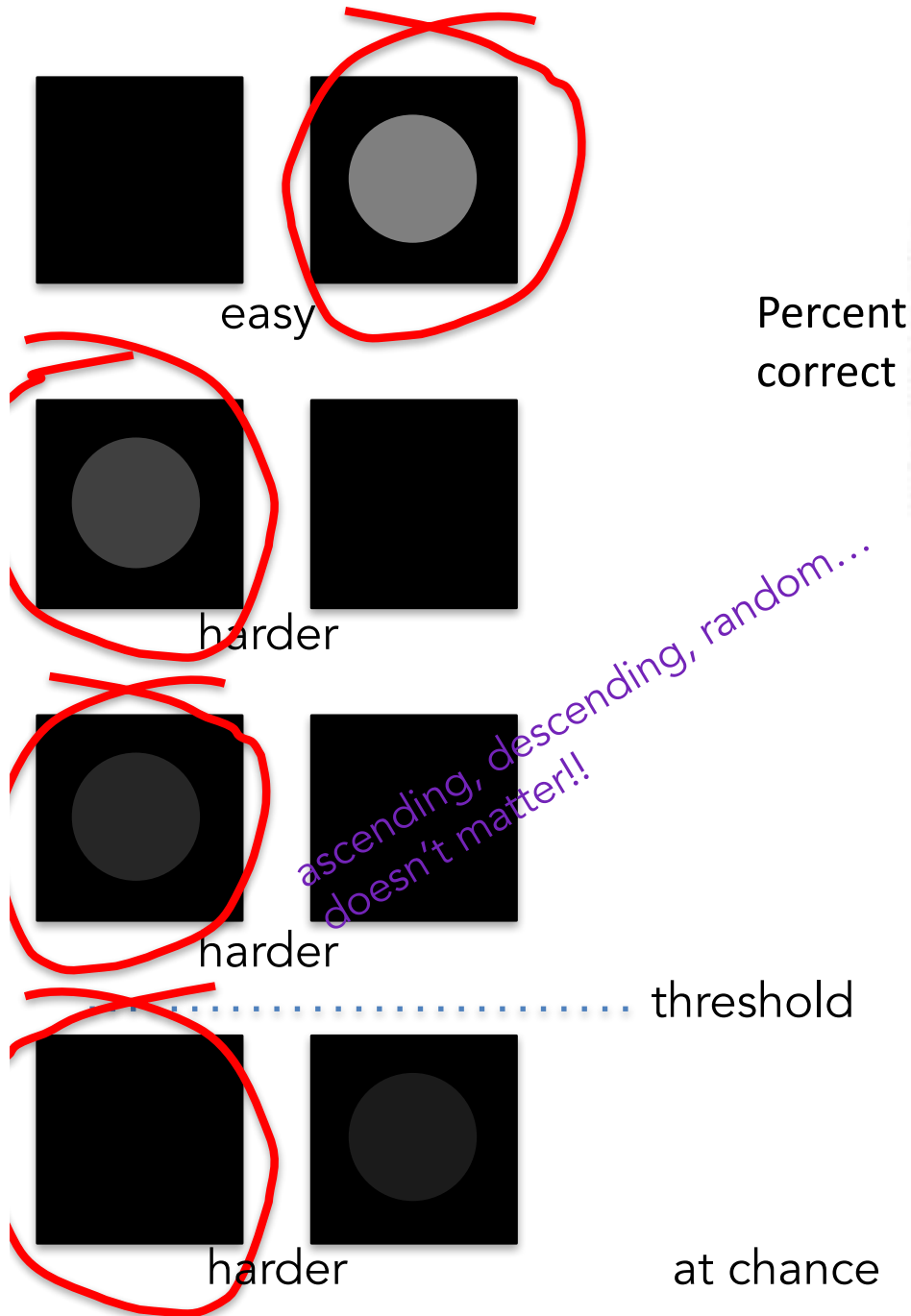

Forced-choice reveals lower thresholds. When forced to choose, subjects usually make better-than-chance choices even when they FEEL like they're just guessing.

"Single-unit psychophysics": Thresholds of intensity discrimination

- Varying frequency of stimulation → varying intensity of sensation
- 2-alternative forced choice (2AFC)



XXX = correct
 --- = wrong

- Start at 200% of baseline (e.g. 120 vs 60 Hz)
- Random presentation order
- "Staircase" with variable difficulty (Zwislocki)
- Stop at n reversals at one level (e.g. 6 reversals)
- Alternative, "random walk" interpretation of results

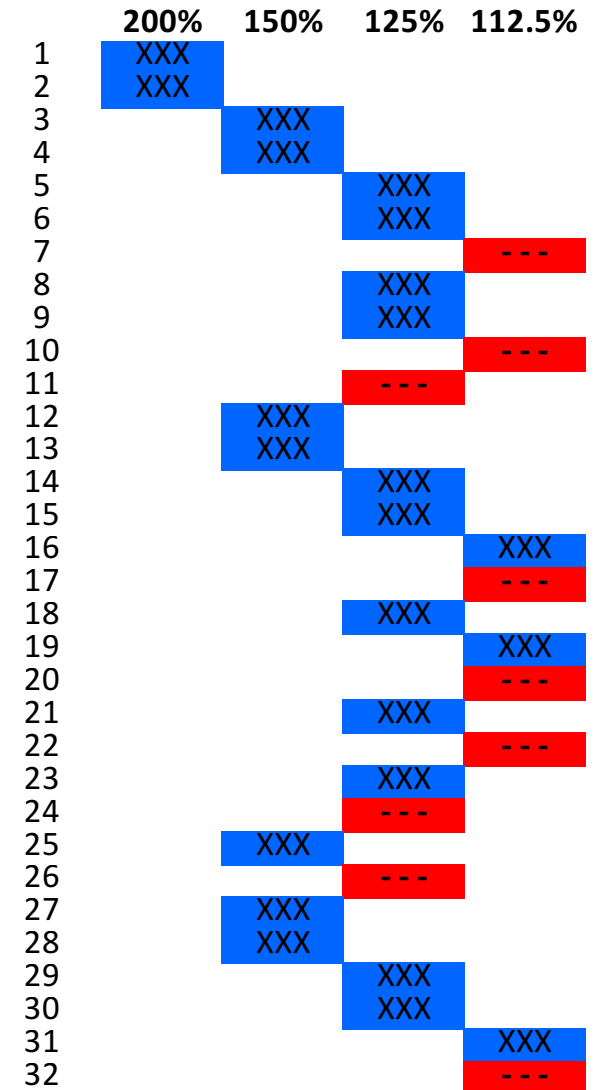

Most intense?

Stim. nr.

2

~~WRONG~~

Psychophysical thresholds for intensity discrimination

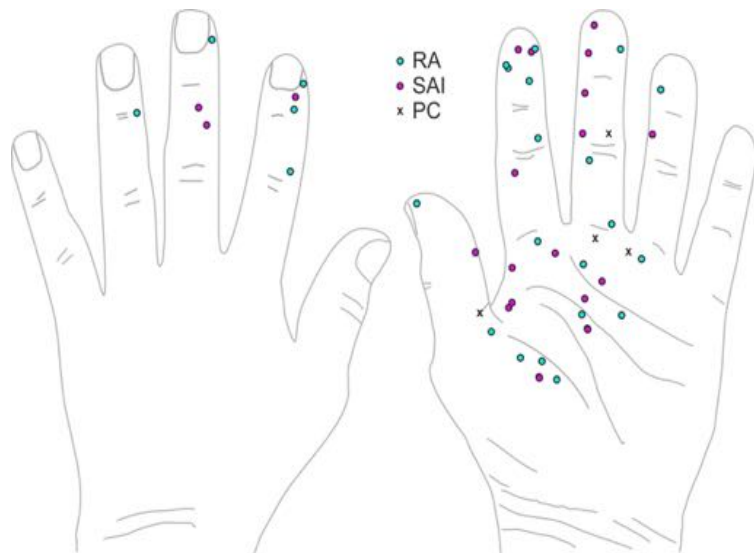

Data sample:

164 tested afferents

75 SAI, 66 RA, 11 Pc, 12 (3) SAII

Adrian & Zotterman (1926): modulation of pulse frequency in a single afferent unit may be sufficient to signal the intensity of a stimulus

Staircase reversals (n=39)

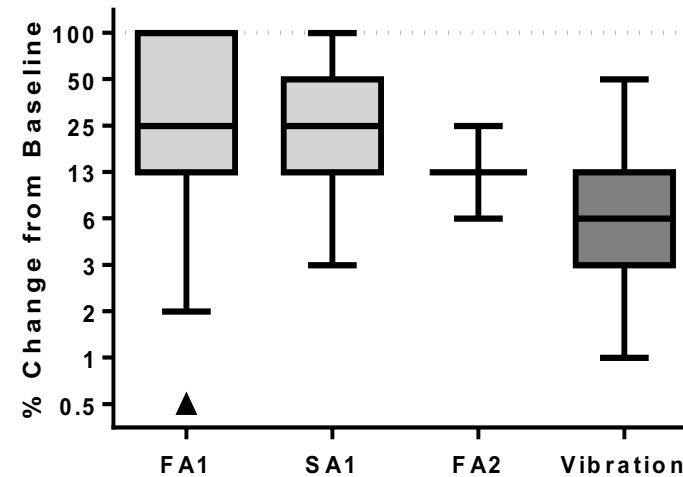

Forced-Choice Psychometric Functions

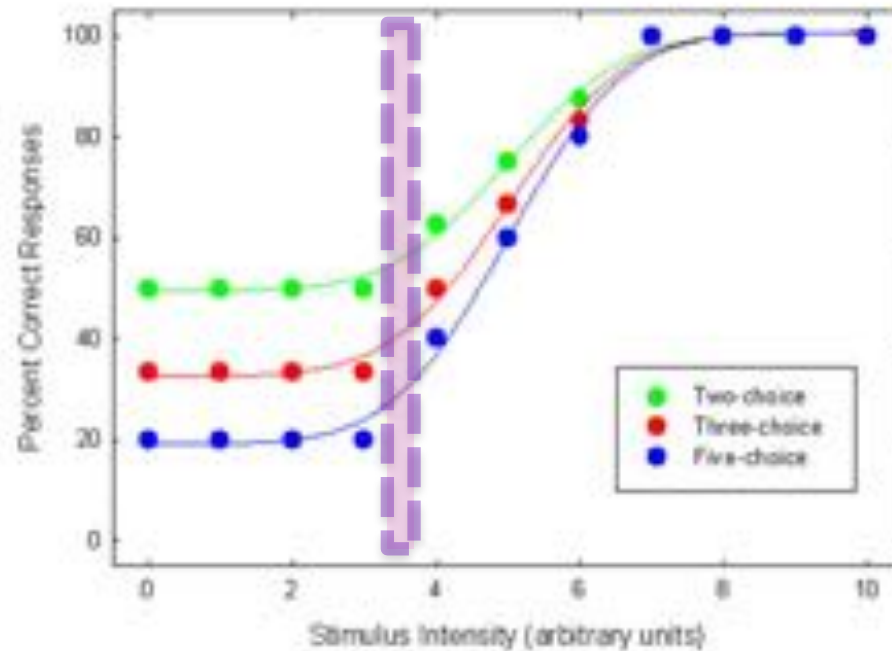

Forced-choice psychometric functions for 2-alternative (green), 3-alternative (red) and 5-alternative (blue) tasks.

Note that chance performance (the percent correct you obtain from merely guessing) varies with the number of alternatives.

Indep. of n. alternatives, threshold is deviation from chance!!

Forced-choice paradigms can be used to measure the sensory capacities of non-verbal subjects (human or animal).

Moreover, can be used for any sensory modality.

- so far -- Absolute Threshold, e.g., stimulus amplitude required for detection against a fixed background.
- more general type of threshold is Difference Threshold -- the size of the difference between two stimuli required in order to just tell them apart.
- another term for the Difference Threshold is the "Just-Noticeable Difference" (JND).
- define the intensity of a "standard" stimulus as I_O , and the intensity of a "test" stimulus as I_T . Differential sensitivity, or "acuity," refers to the smallest increase in stimulus strength ($I_T - I_O$) which can be detected on the background of the "standard" stimulus I_O . The difference ($I_T - I_O$) is known as ΔI .
- threshold value of ΔI is the JND.

common experiment is to measure the threshold ΔI (the JND) while changing, in randomized steps, the intensity of the background "standard" stimulus (I_0).

This reveals how the "standard" background level affects visual sensitivity, that is, affects the size of the JND.

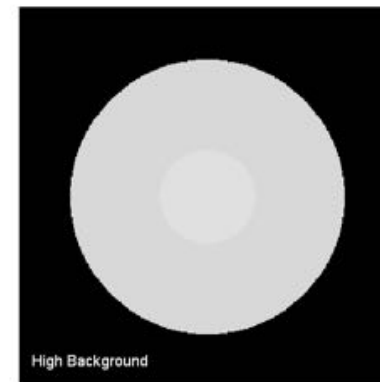
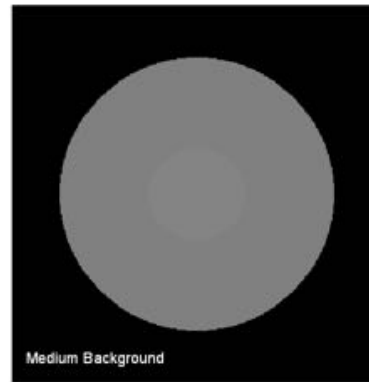
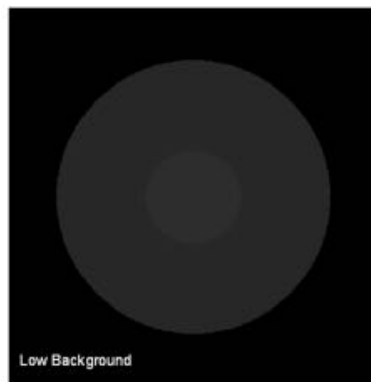

- Weber (1800s) performed such experiments & discovered a surprising relationship between I_0 and ΔI .
- Over a wide range of stimulus intensities, $\Delta I = kI_0$.
This expression can be rewritten as $\Delta I / I_0 = k$.
- In other words, JND is not an absolute quantity of stimulus, but is a constant proportion of the background "standard" stimulus, I_0 .
- Larger increments required for them to be "seen" on "standard" backgrounds of increasing intensity is illustrated in the three figures below

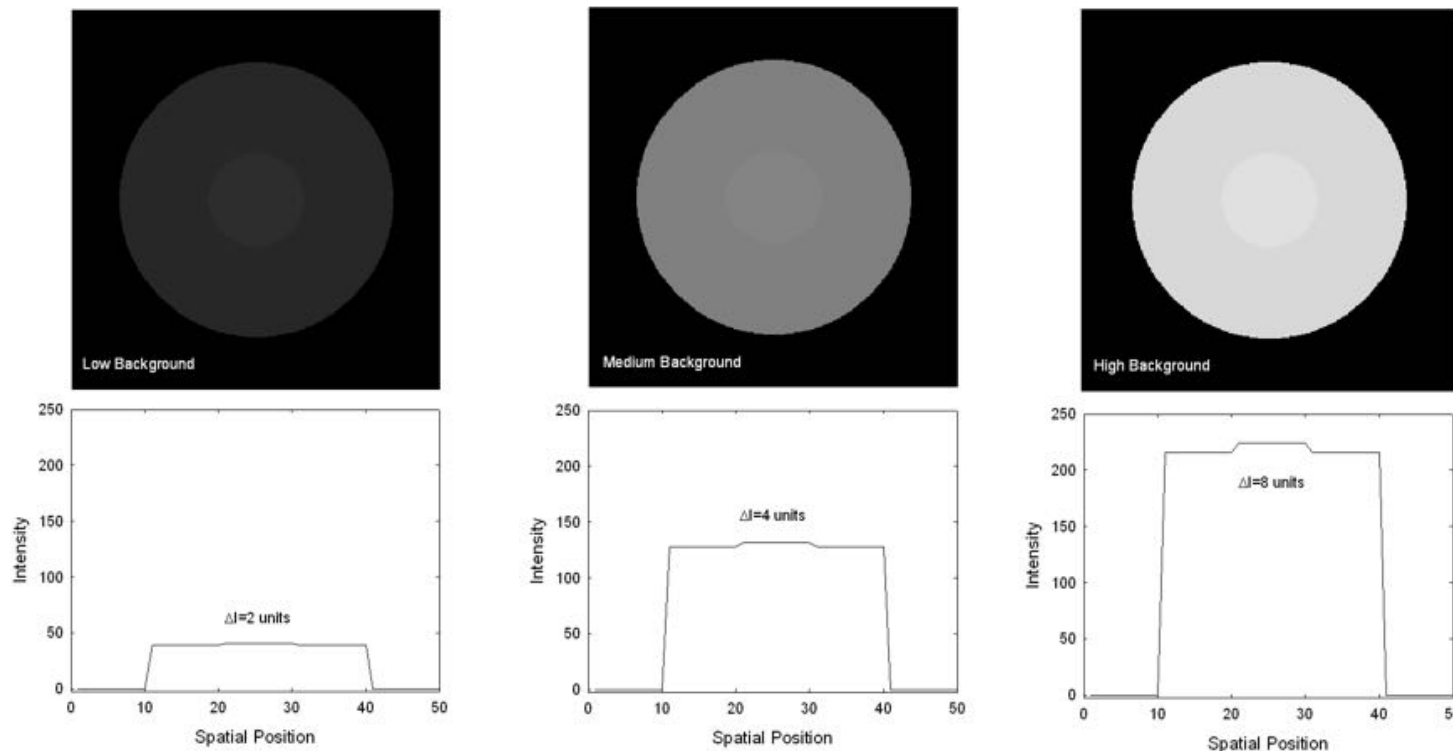

- So the more intense the background stimulus, the larger the increment needed for it to be detected on top of the background. The k in the equation $\Delta I = kI_0$ is called the **constant of proportionality** -- it determines how fast the threshold increment rises with increasing background level.
- The smaller the value of k , the more sensitive is the system. Another name for k is the **Weber Fraction**.
- The value of the Weber fraction varies across sensory systems and across discrimination tasks within given systems, as shown in the table below.

Weber →

Discrimination Task	Weber Fraction (k)
Brightness	0.079
Loudness	0.048
Finger Span	0.022
Heaviness	0.033
Line Length	0.029
Taste (salt)	0.083
Electric Shock	0.013
Vibration (fingertip)	0.036

Weber asked subjects to compare left hand and right hand weights.

The smallest noticeable difference in weight was proportional to the weight to which the difference was added.





The smallest noticeable difference in weight was proportional to the weight to which the difference was added.

This kind of relationship can be described by a differential equation as,

$$dp = k \frac{dS}{S},$$

where dp is the differential change in perception, dS is the differential increase in the stimulus and S is the stimulus at the instant. A constant factor k is to be determined experimentally.

Integrating the above equation gives

$$p = k \ln S + C,$$

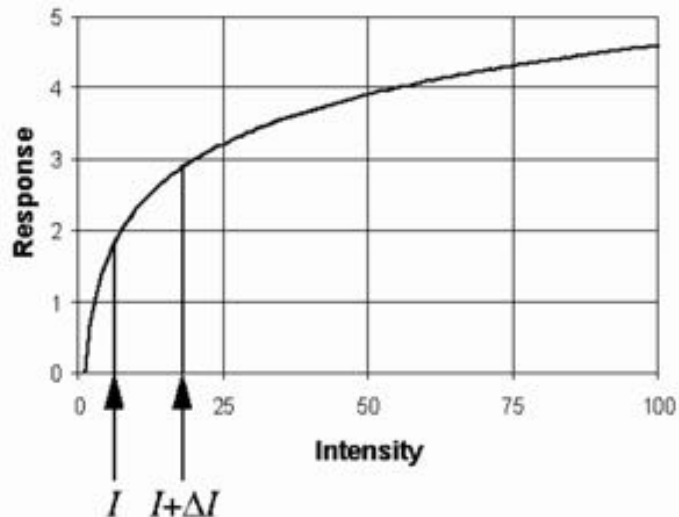



Indeed, across individuals and across entire societies, feeling of socioeconomic “wellbeing” is to some extent predicted by overall income but is much better fit by change of income per unit of time divided by base income... a Weber relation.

- For weight discrimination using one's finger, $k = 1/30$ (.0333). This means that a 1 kg weight can be discriminated from another weighing $1 + 1[1/30]$, or 1.0333 kg.
- How large an increment would be required to detect a change in a 10 kg weight?

$10 + 10[1/30] = 10.333$ kg. A much larger absolute increase, but an equal proportion of I_0 .

Weber →

Discrimination Task	Weber Fraction (k)
Brightness	0.079
Loudness	0.048
Finger Span	0.022
Heaviness	0.033
Line Length	0.029
Taste (salt)	0.083
Electric Shock	0.013
Vibration (fingertip)	0.036

Fechner's Law is derived from Weber's Law through integration (replace ΔI with Ψ , the perceived magnitude):

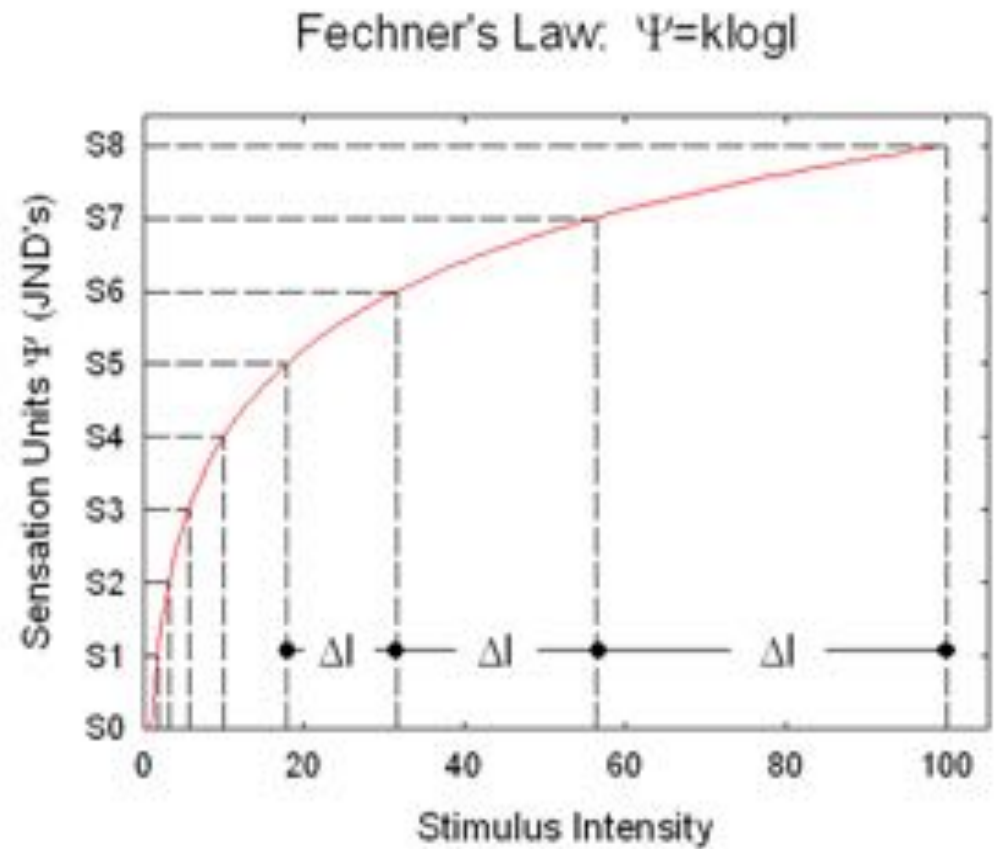

Fechner's Law states that equal increments in sensory experience (Ψ) are proportional (k) to the logarithm of stimulus magnitude (I): $\Psi = k \log I$.

constant differences in the percept are the result of constant ratios of physical stimuli.

assume that doubling intensity of a light stimulus (20 to 40) increases perceived brightness by 30%

what is perceived brightness if intensity doubled again (40 to 80)?

it increases it by another 30%.

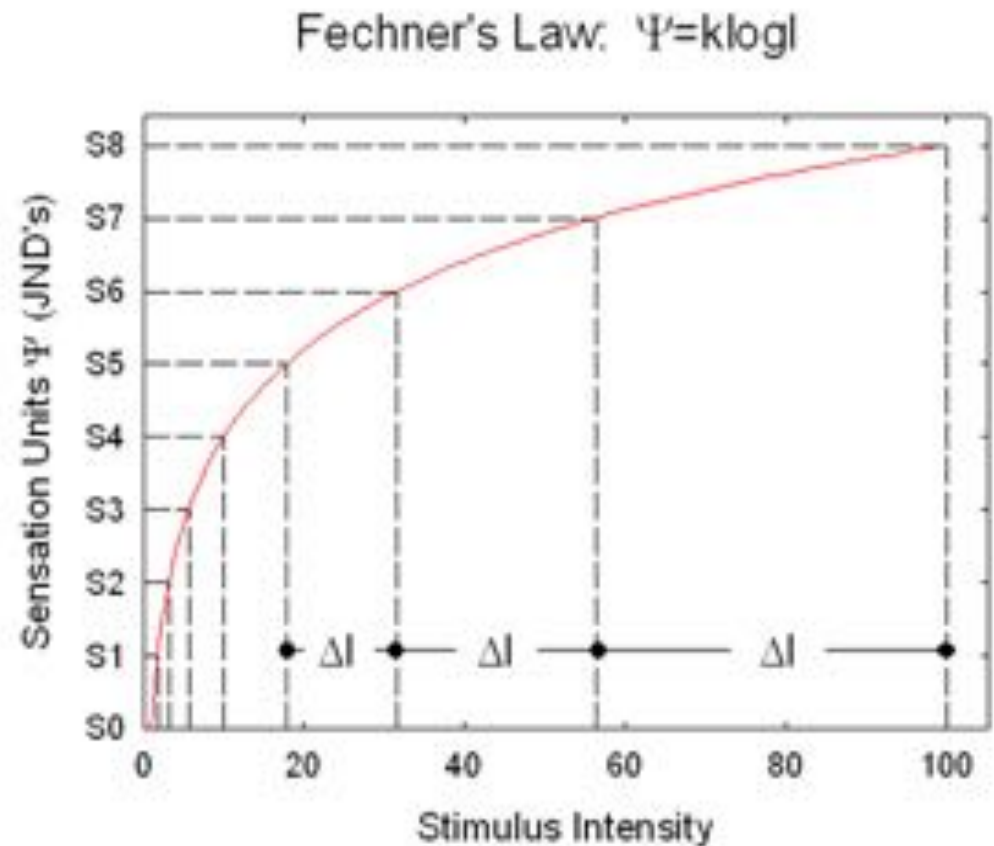



Weber gradually increased the weight that a blindfolded man was holding: respond when weight changes. The smallest noticeable difference in weight was proportional to the weight to which the difference was added.

This kind of relationship can be described by a differential equation as,

$$dp = k \frac{dS}{S},$$

where dp is the differential change in perception, dS is the differential increase in the stimulus and S is the stimulus at the instant. A constant factor k is to be determined experimentally.

Integrating the above equation gives

$$p = k \ln S + C,$$



Example – muscle spindle

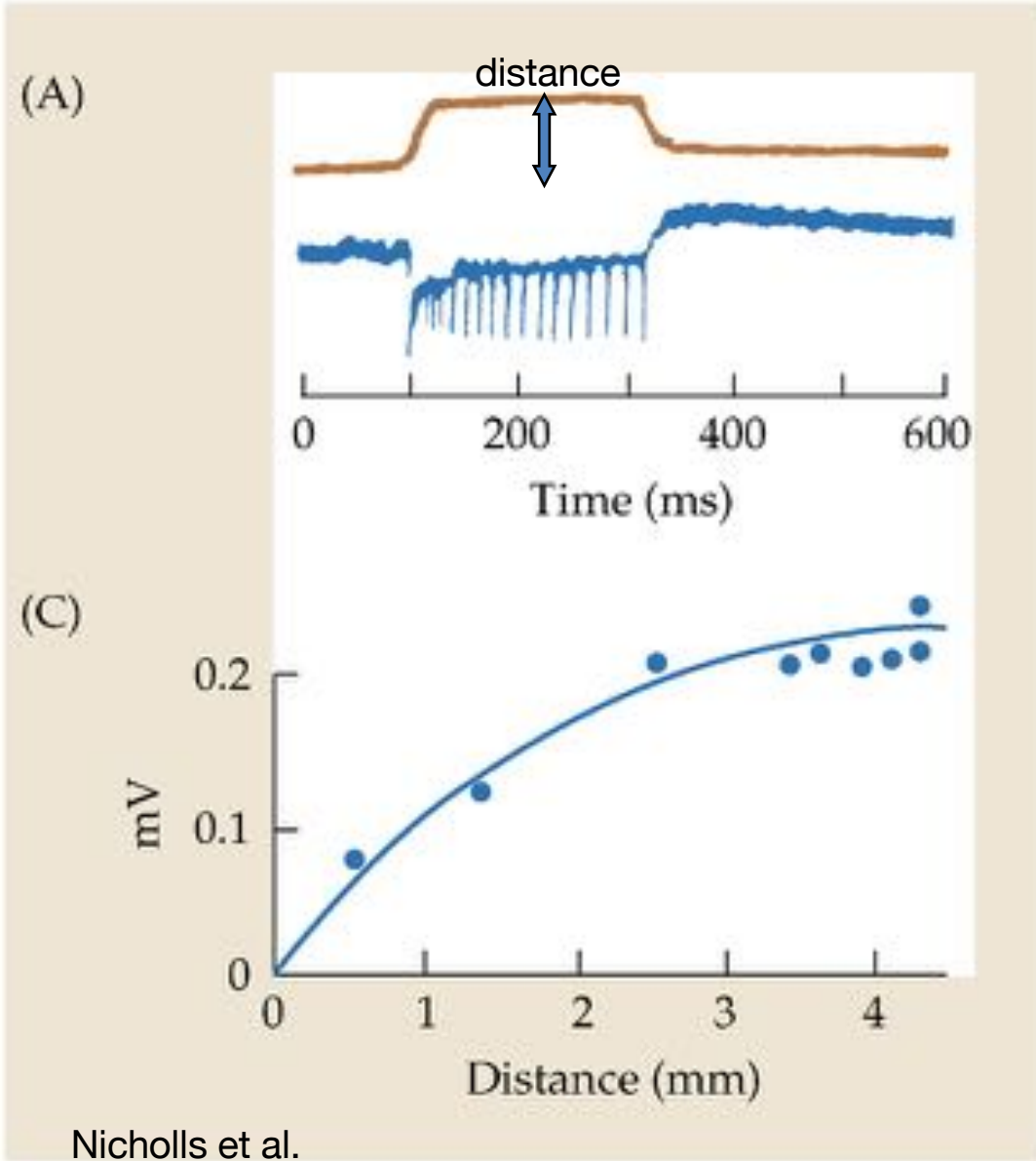

Many sensory receptors take advantage of this nonlinear relationship to provide amplitude coding over a wide range of stimulus intensities: response amplitude continues to increase, but in proportion to the logarithm of stimulus intensity. T

cognitive neuroscientists – if you think receptor properties don't matter in perception, think of **Weber-Fechner law** (1846).

Nicholls et al.
(After Katz, 1950)

psychophysics

 measuring neuronal activity

building an apparatus

monitoring behavior

Measuring neuronal activity in behaving animals (rodents)

Principal current methods

METHOD	HOW IT WORKS	TREND	TEMPORAL RE-SOLUTION	SPATIAL RE-SOLUTION	STATE of ANIMAL	COMMENTS
Functional magnetic resonance imaging	Blood oxygenation	Under development	100s of millisec (getting better?)	mm (getting better?)	immobile	<ul style="list-style-type: none">• super-expensive• WHOLE BRAIN

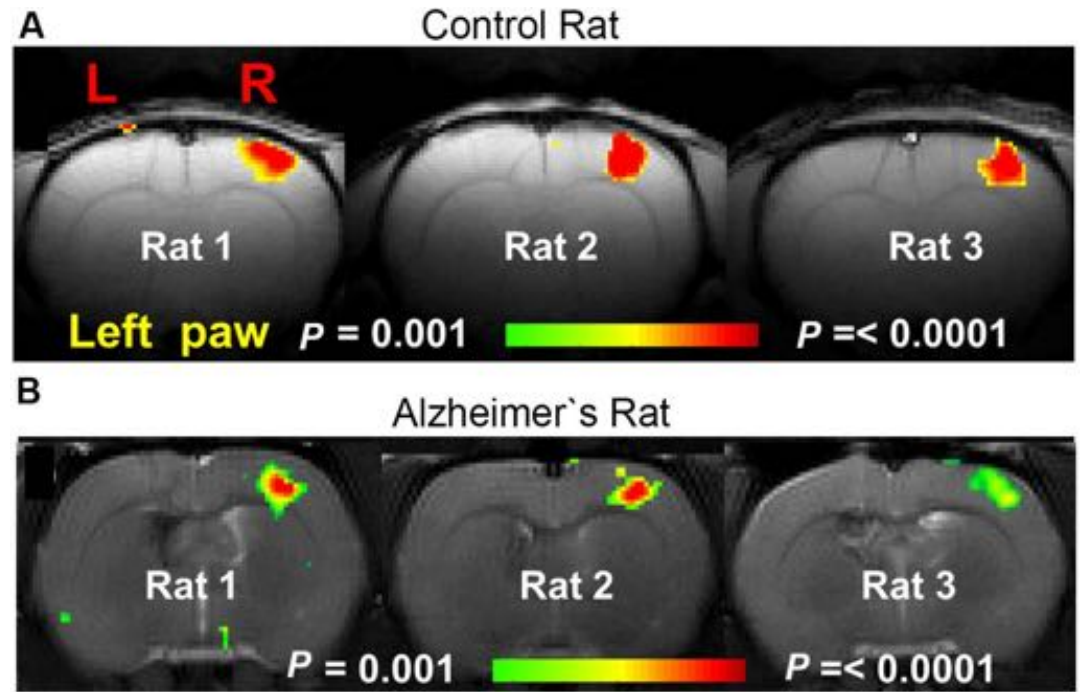
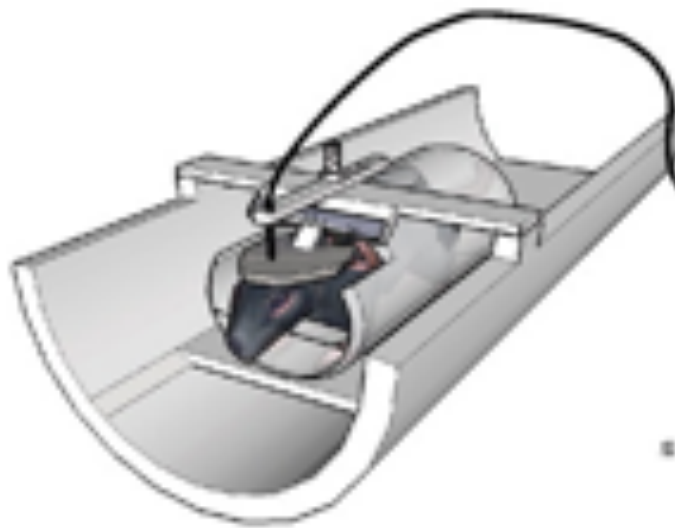
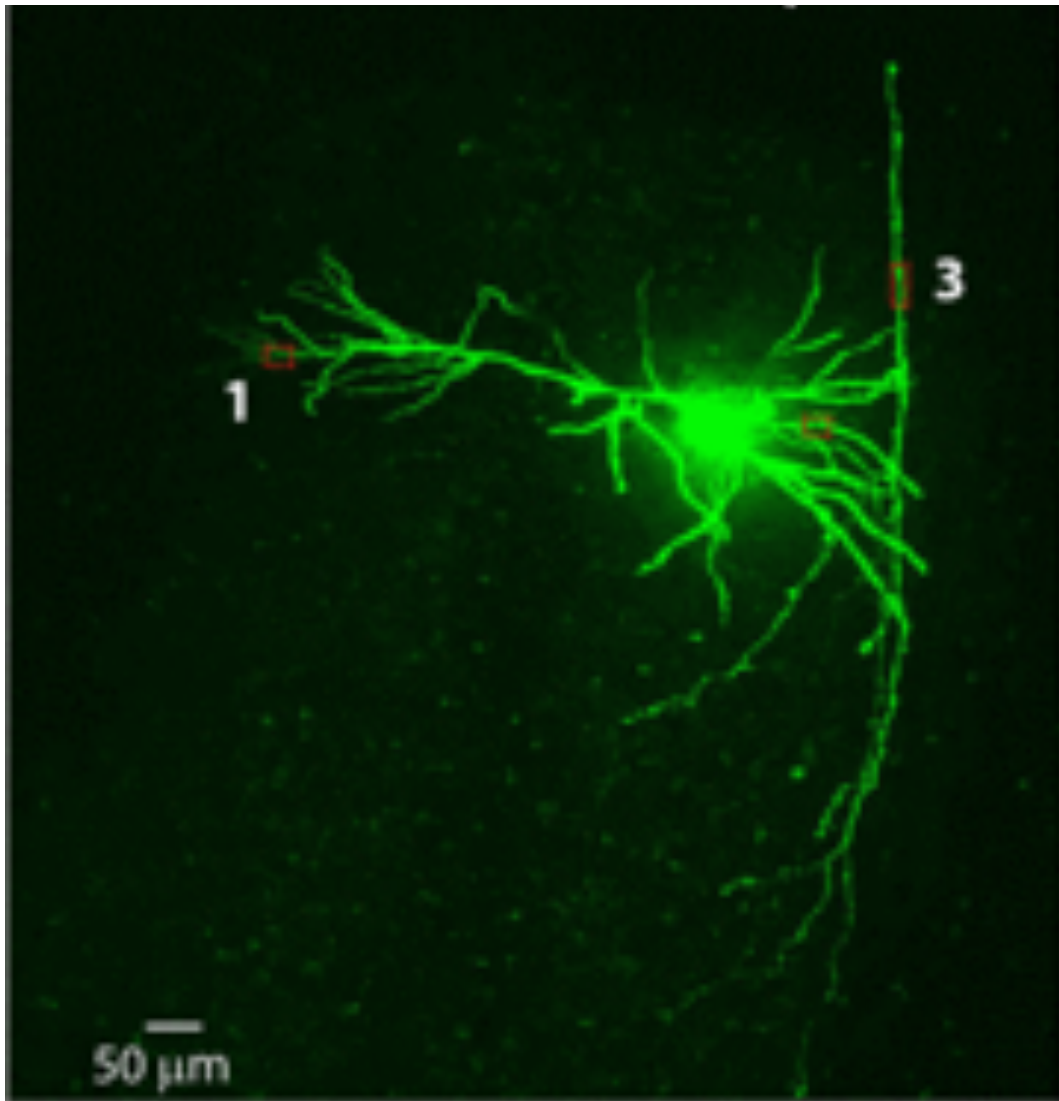

FIGURE 8. BOLD activation maps during contralateral forepaw stimulation in (A) control rat and (B) AD rat. Rats were anesthetized with α -chloralose and ventilated. Much smaller BOLD activation patterns were observed in the somatosensory forelimb cortex (S1FL) in the AD rats compared to the control rats [Figure based on the results shown in with permission of the author (Sanganahalli et al., 2013)].

Measuring neuronal activity in behaving animals (rodents)

Principal current methods

METHOD	HOW IT WORKS	TREND	TEMPORAL RE-SOLUTION	SPATIAL RE-SOLUTION	STATE of ANIMAL	COMMENTS
Functional magnetic resonance imaging	Blood oxygenation	Under development	100s of millisec (getting better?)	mm (getting better?)	immobile	<ul style="list-style-type: none"> • super-expensive • WHOLE BRAIN
Voltage sensitive dye imaging	Neurons absorb molecule that fluoresces with depolarization	Decreasing popularity	ms	cellular	anesthetized or head-fixed	<ul style="list-style-type: none"> • toxic, non-repeatable • cerebral cortex, superficial layers



neuron in cerebral cortex

voltage-sensitive dye imaging

Measuring neuronal activity in behaving animals (rodents)

Principal current methods

METHOD	HOW IT WORKS	TREND	TEMPORAL RE-SOLUTION	SPATIAL RE-SOLUTION	STATE of ANIMAL	COMMENTS
Functional magnetic resonance imaging	Blood oxygenation	Under development	100s of millisec (getting better?)	mm (getting better?)	immobile	<ul style="list-style-type: none"> • super-expensive • WHOLE BRAIN
Voltage sensitive dye imaging	Neurons absorb molecule that fluoresces with depolarization	Decreasing popularity	ms	cellular	anesthetized or head-fixed	<ul style="list-style-type: none"> • toxic, non-repeatable • cerebral cortex, superficial layers

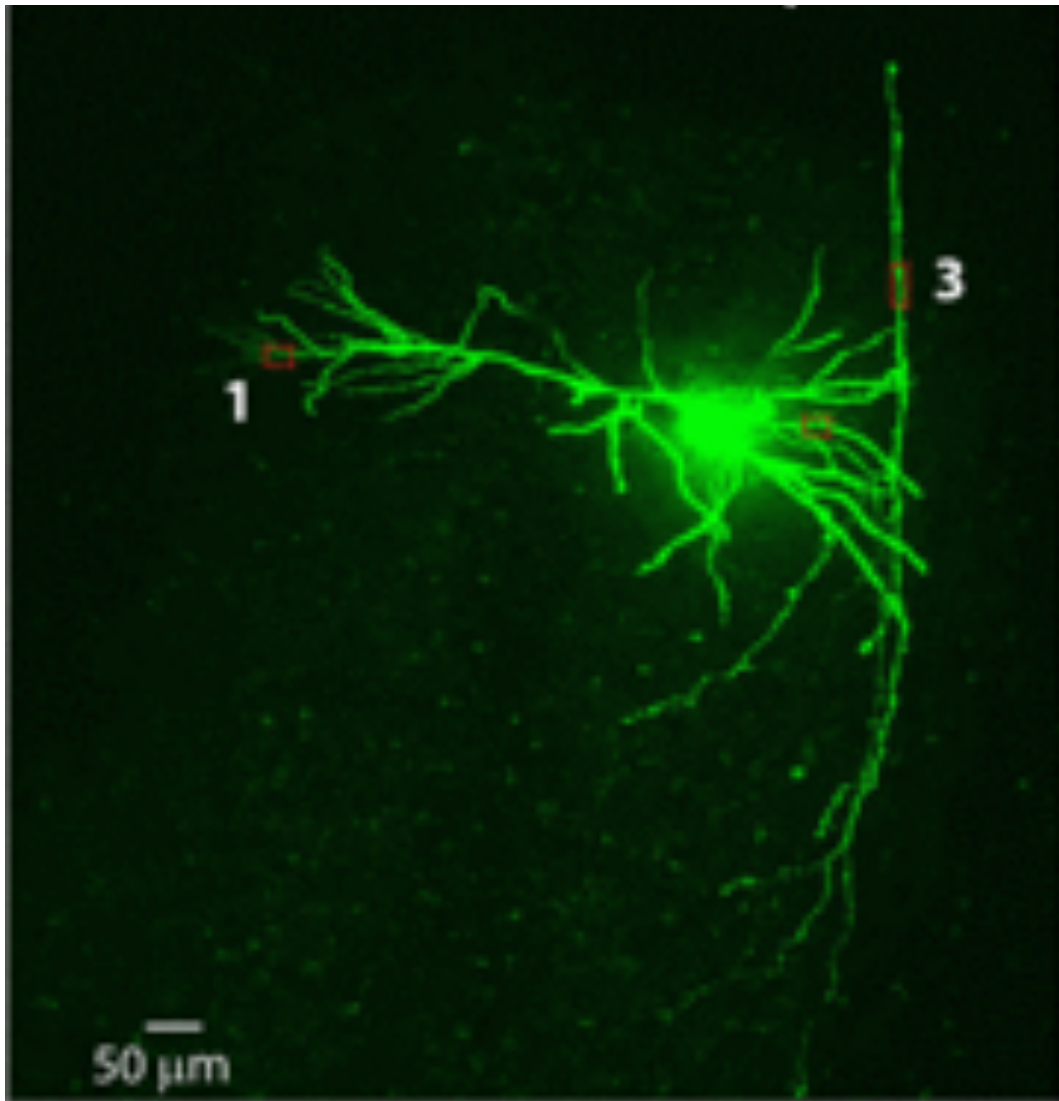

neuron in cerebral cortex

voltage-sensitive dye imaging

Measuring neuronal activity in behaving animals (rodents)

Principal current methods

METHOD	HOW IT WORKS	TREND	TEMPORAL RE-SOLUTION	SPATIAL RE-SOLUTION	STATE of ANIMAL	COMMENTS
Functional magnetic resonance imaging	Blood oxygenation	Under development	100s of millisec (getting better?)	mm (getting better?)	immobile	<ul style="list-style-type: none"> • super-expensive • WHOLE BRAIN
Voltage sensitive dye imaging	Neurons absorb molecule that fluoresces with depolarization	Decreasing popularity	ms	cellular	anesthetized or head-fixed	<ul style="list-style-type: none"> • toxic, non-repeatable • cerebral cortex, superficial layers
Calcium imaging	Molecule inside neuron fluoresces when binds to Ca ⁺⁺	Increasing popularity; <u>genetics</u>	10s of ms (but improving)	cellular	anesthetized or head-fixed however...	<ul style="list-style-type: none"> • expensive, requires expertise • mouse (not rat) • cerebral cortex, superficial layers

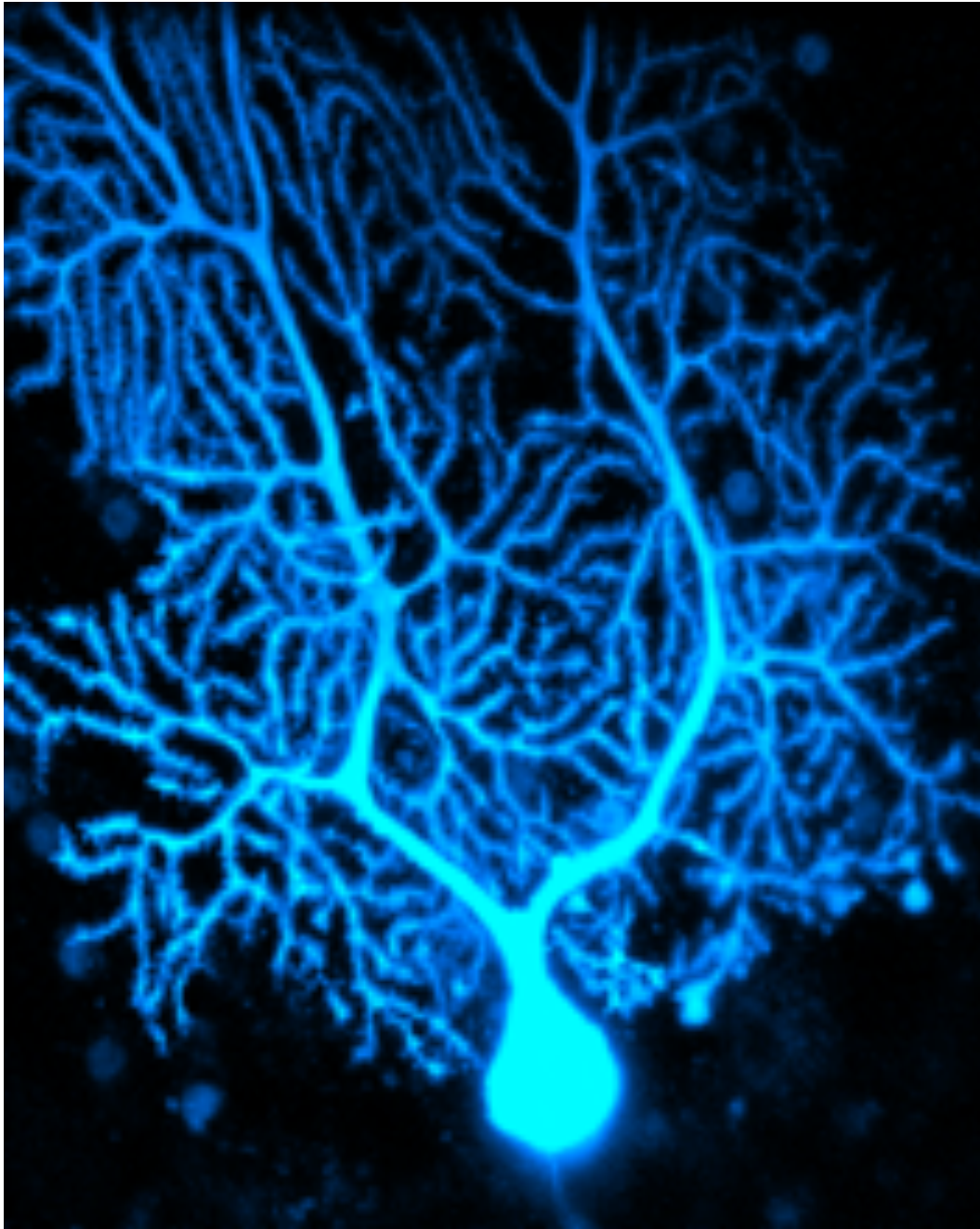

neuron in cerebellum

Ca⁺⁺ imaging

[https://www.youtube.com/
watch?v=tRPuVAVXk2M](https://www.youtube.com/watch?v=tRPuVAVXk2M)

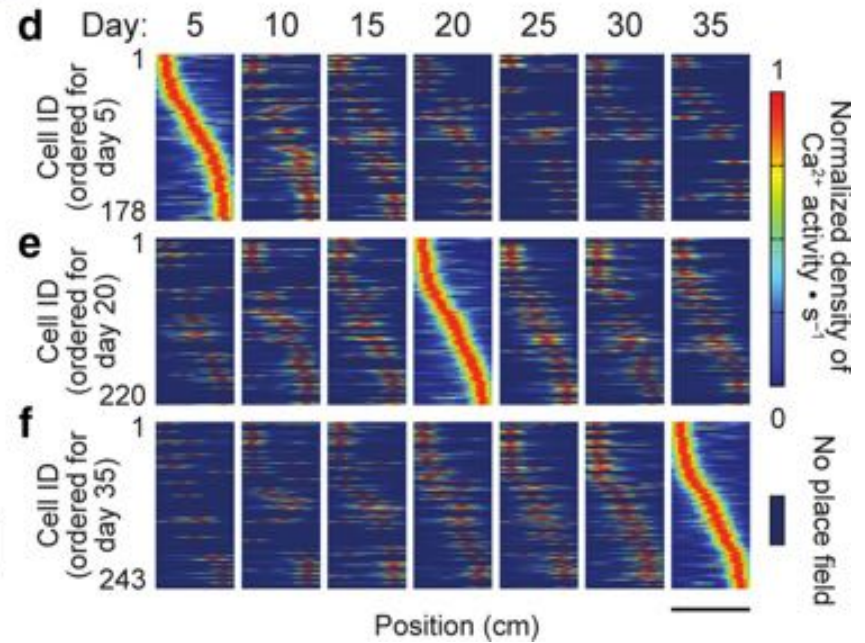
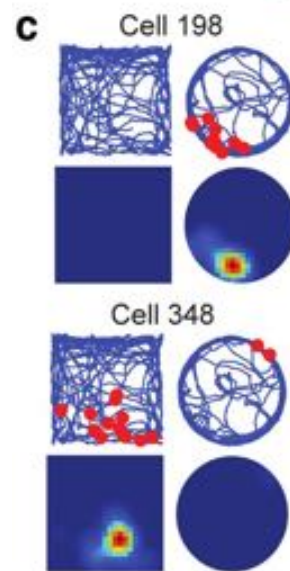
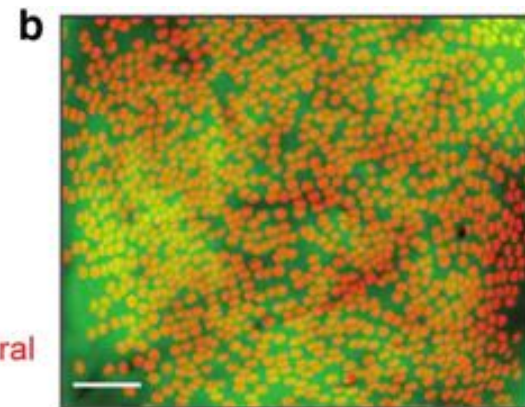
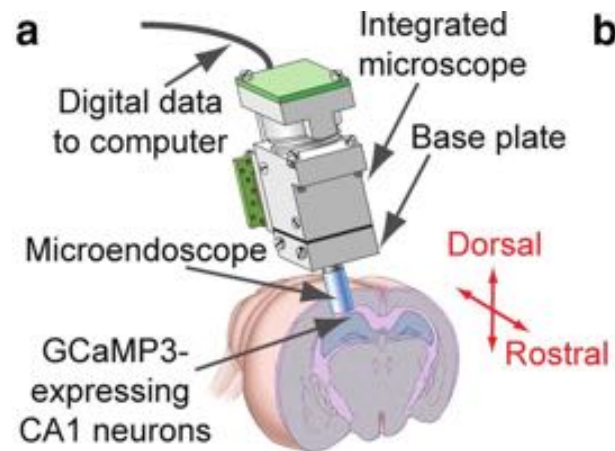
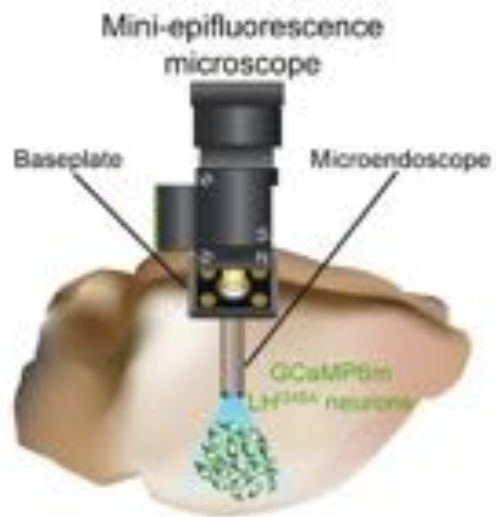

Measuring neuronal activity in behaving animals (rodents)

Principal current methods

METHOD	HOW IT WORKS	TREND	TEMPORAL RE-SOLUTION	SPATIAL RE-SOLUTION	STATE of ANIMAL	COMMENTS
Functional magnetic resonance imaging	Blood oxygenation	Under development	100s of millisec (getting better?)	mm (getting better?)	immobile	<ul style="list-style-type: none"> • super-expensive • WHOLE BRAIN
Voltage sensitive dye imaging	Neurons absorb molecule that fluoresces with depolarization	Decreasing popularity	ms	cellular	anesthetized or head-fixed	<ul style="list-style-type: none"> • toxic, non-repeatable • cerebral cortex, superficial layers
Calcium imaging	Molecule inside neuron fluoresces when binds to Ca ⁺⁺	Increasing popularity; <u>genetics</u>	10s of ms (but improving)	cellular	anesthetized or head-fixed however...	<ul style="list-style-type: none"> • expensive, requires expertise • mouse (not rat) • cerebral cortex, superficial layers
Electrophysiology	Conduction of action potentials thru metal micro-electrode	Classical, yet continuously improving	ms	cellular	head-fixed or even freely moving	<ul style="list-style-type: none"> • contained cost • WHOLE BRAIN • Technically accessible

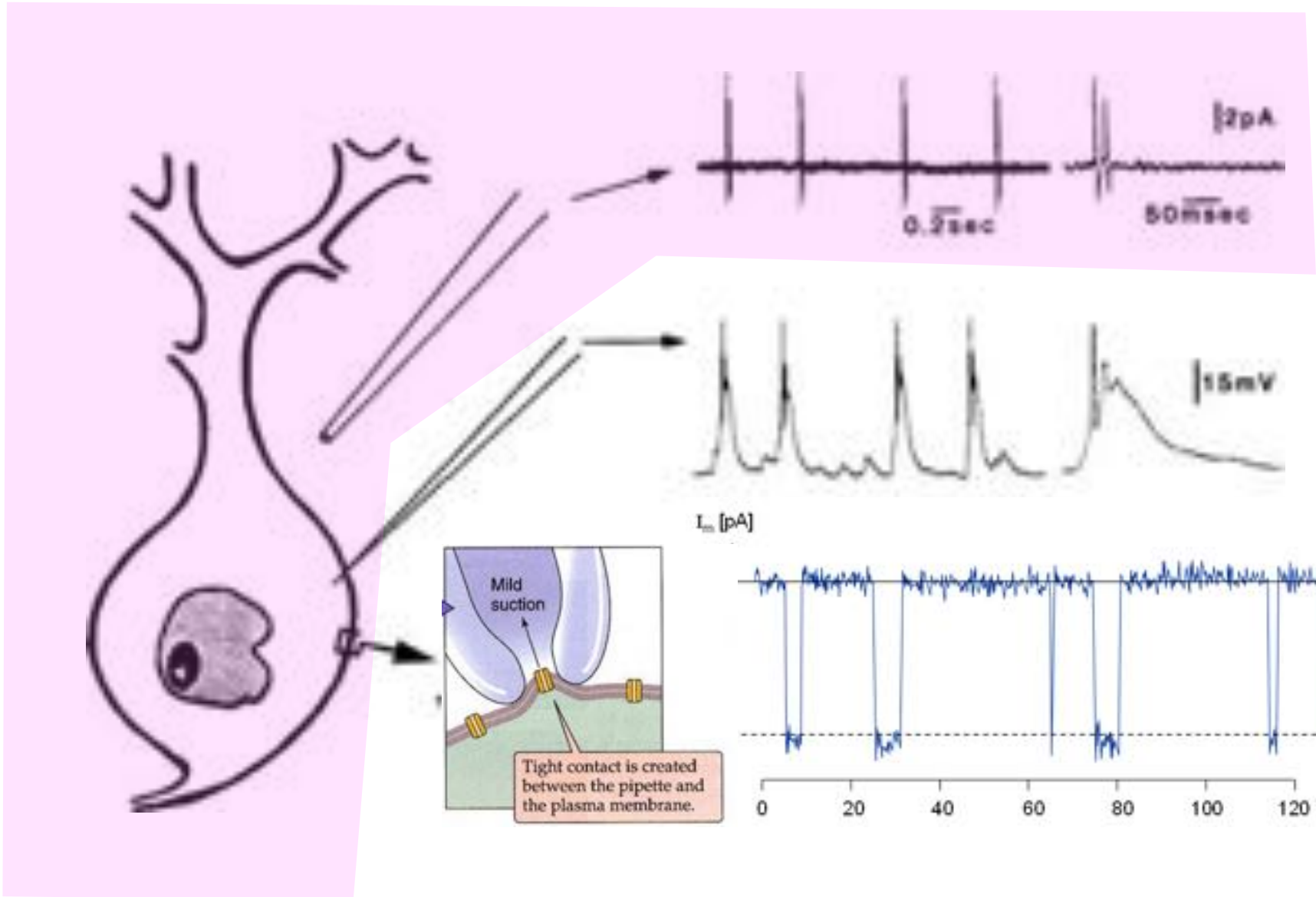

ELECTRODES

grid

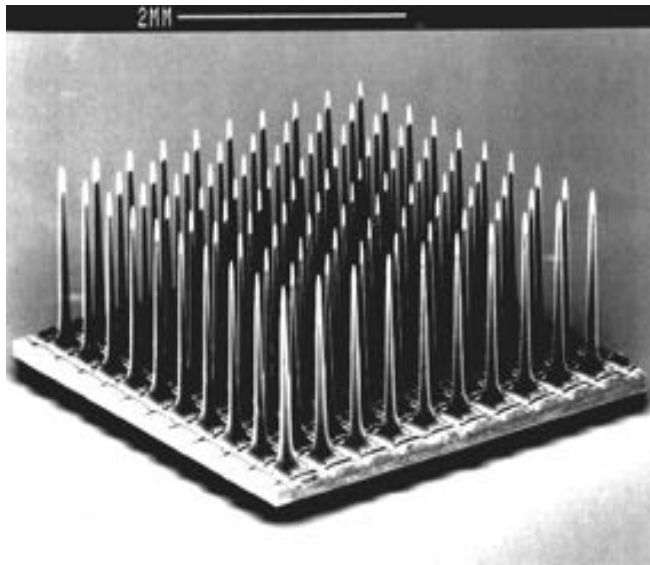

tetrode...

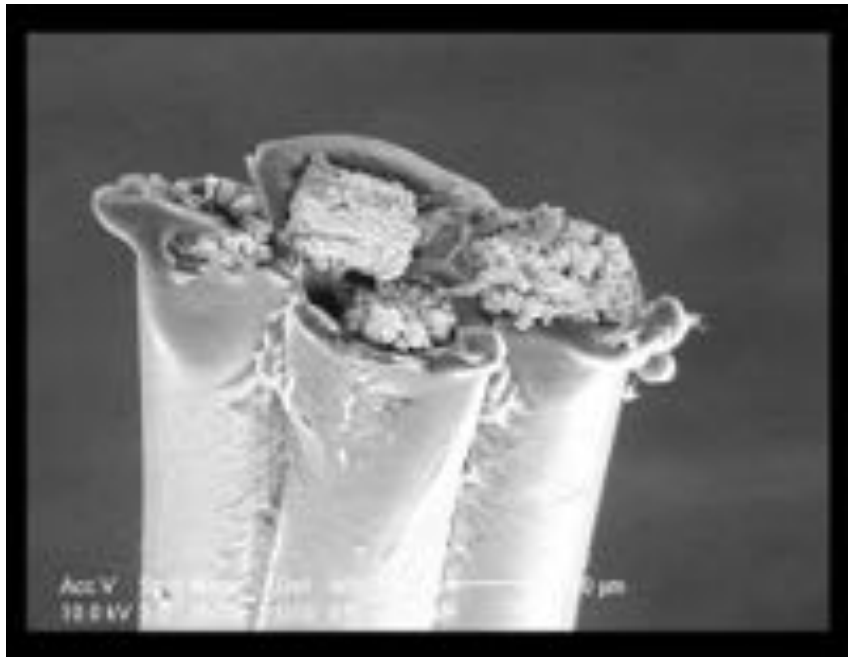

fixed linear array

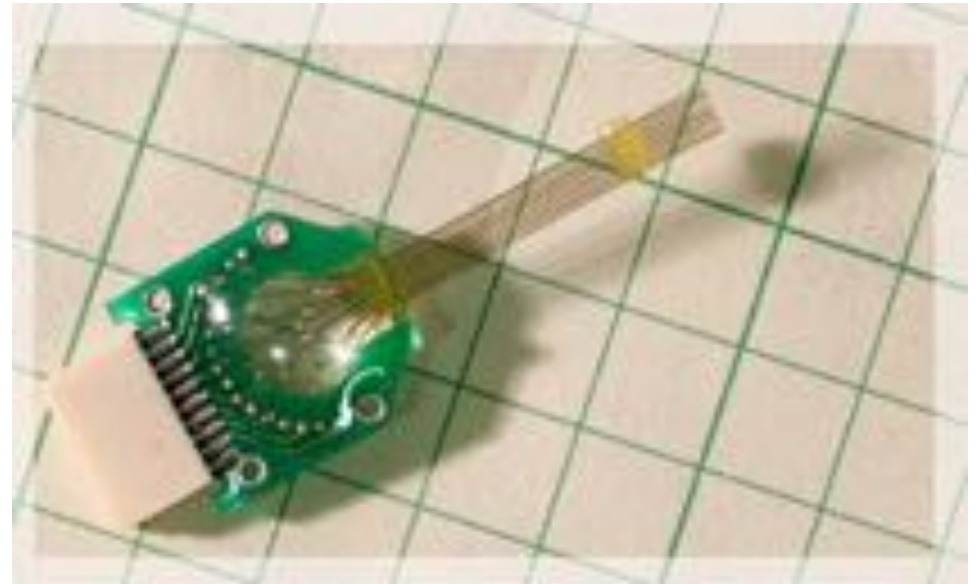

... housed in microdrive





psychophysics

measuring neuronal activity

 building an apparatus

monitoring behavior

How do rats perceive textures with their whiskers?

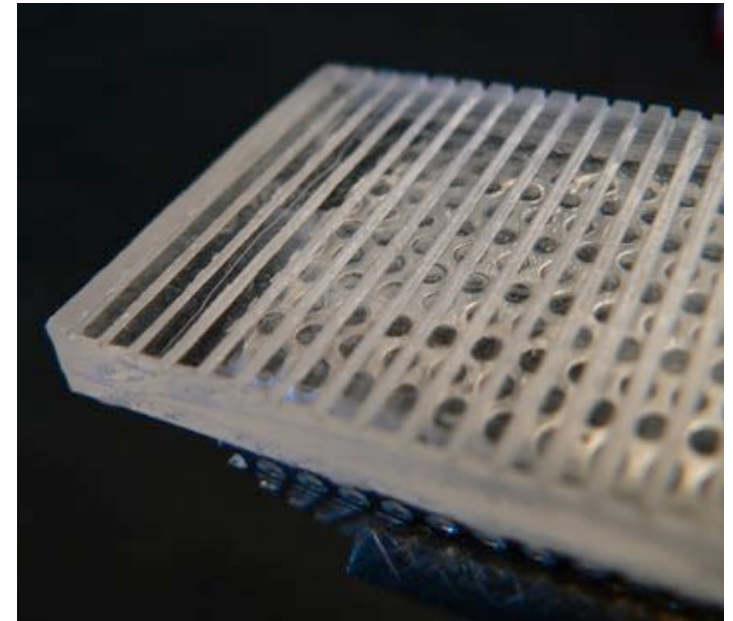
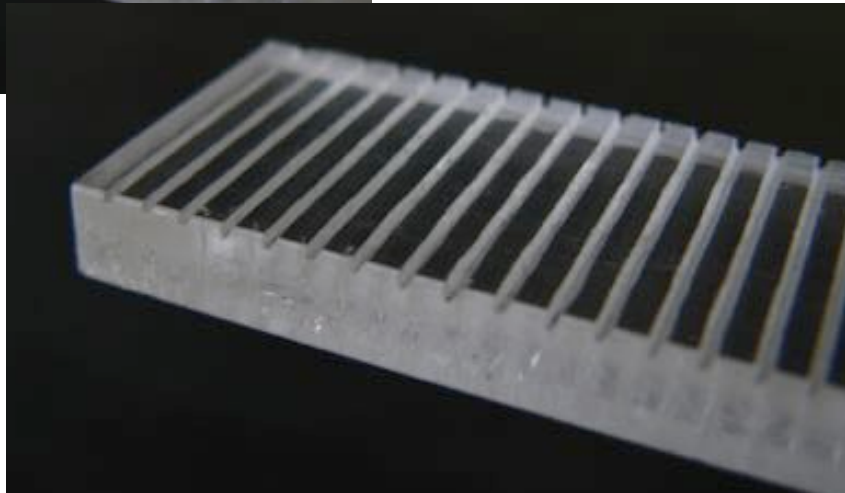
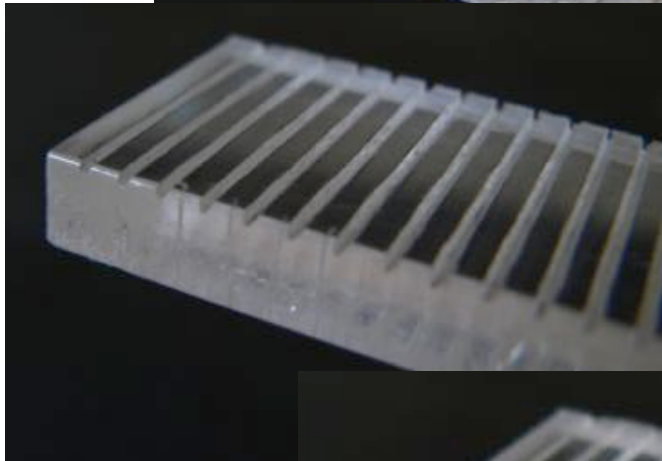
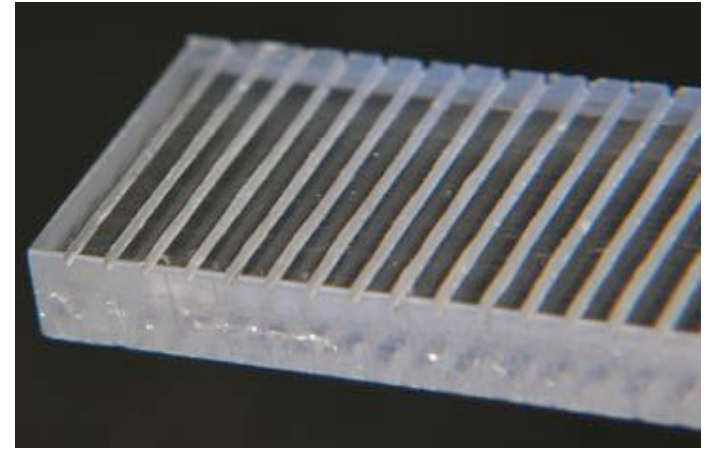
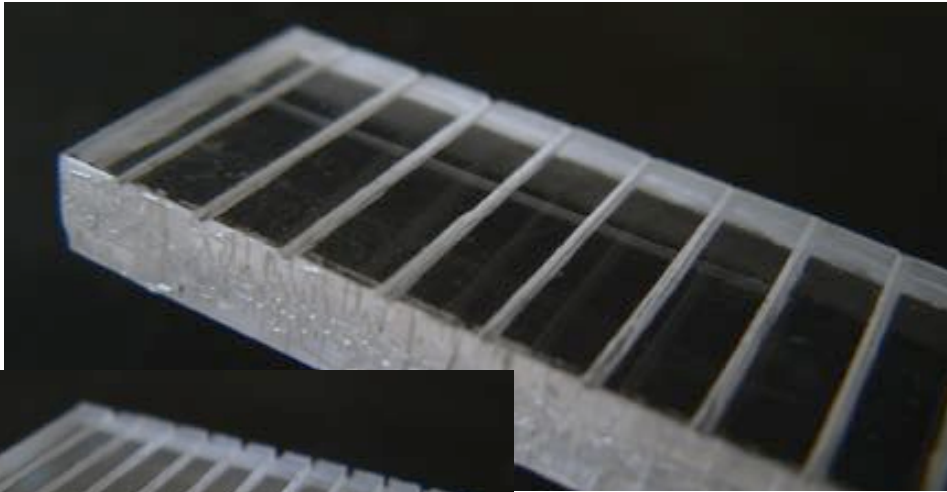

1999

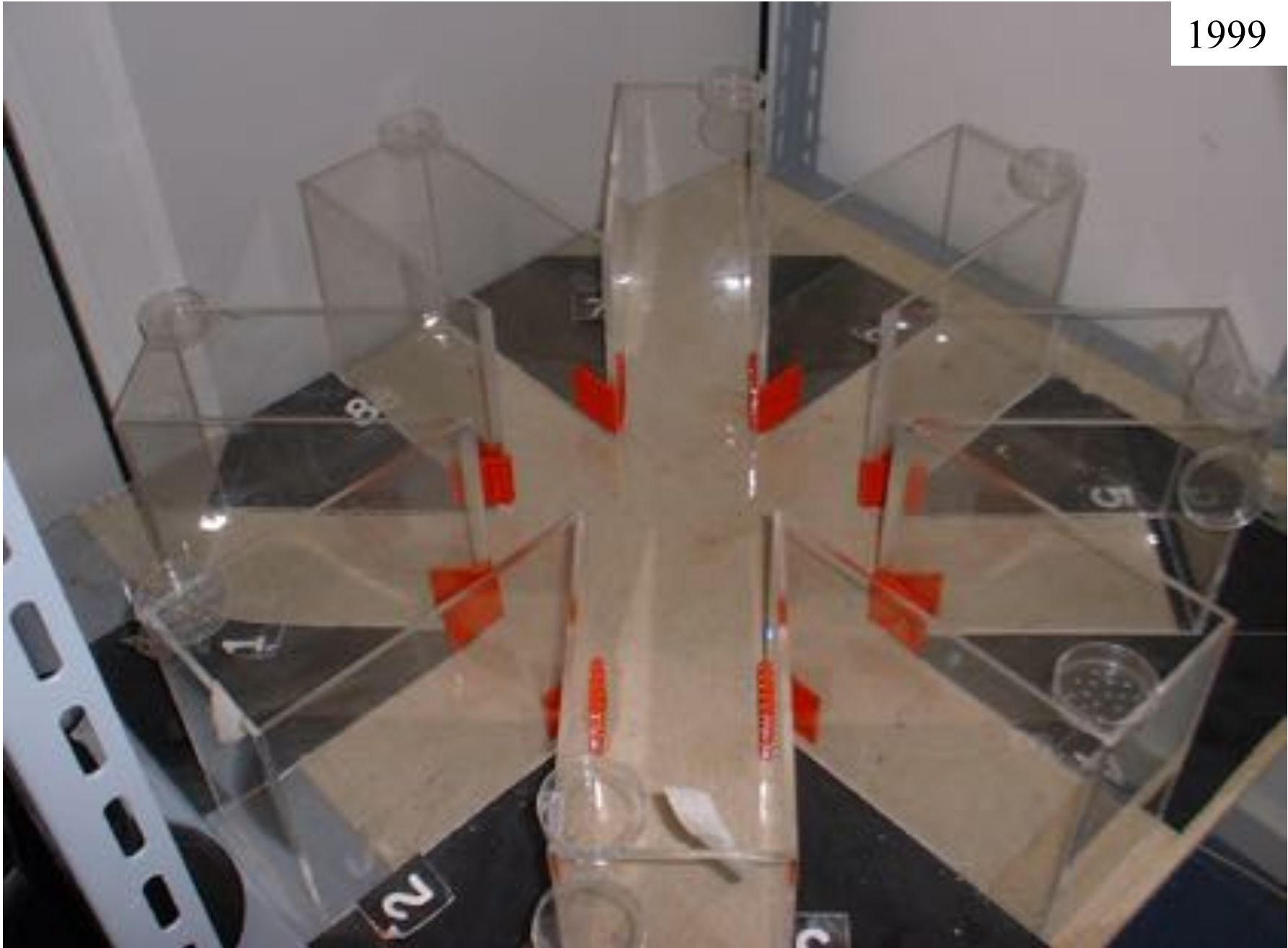

2003

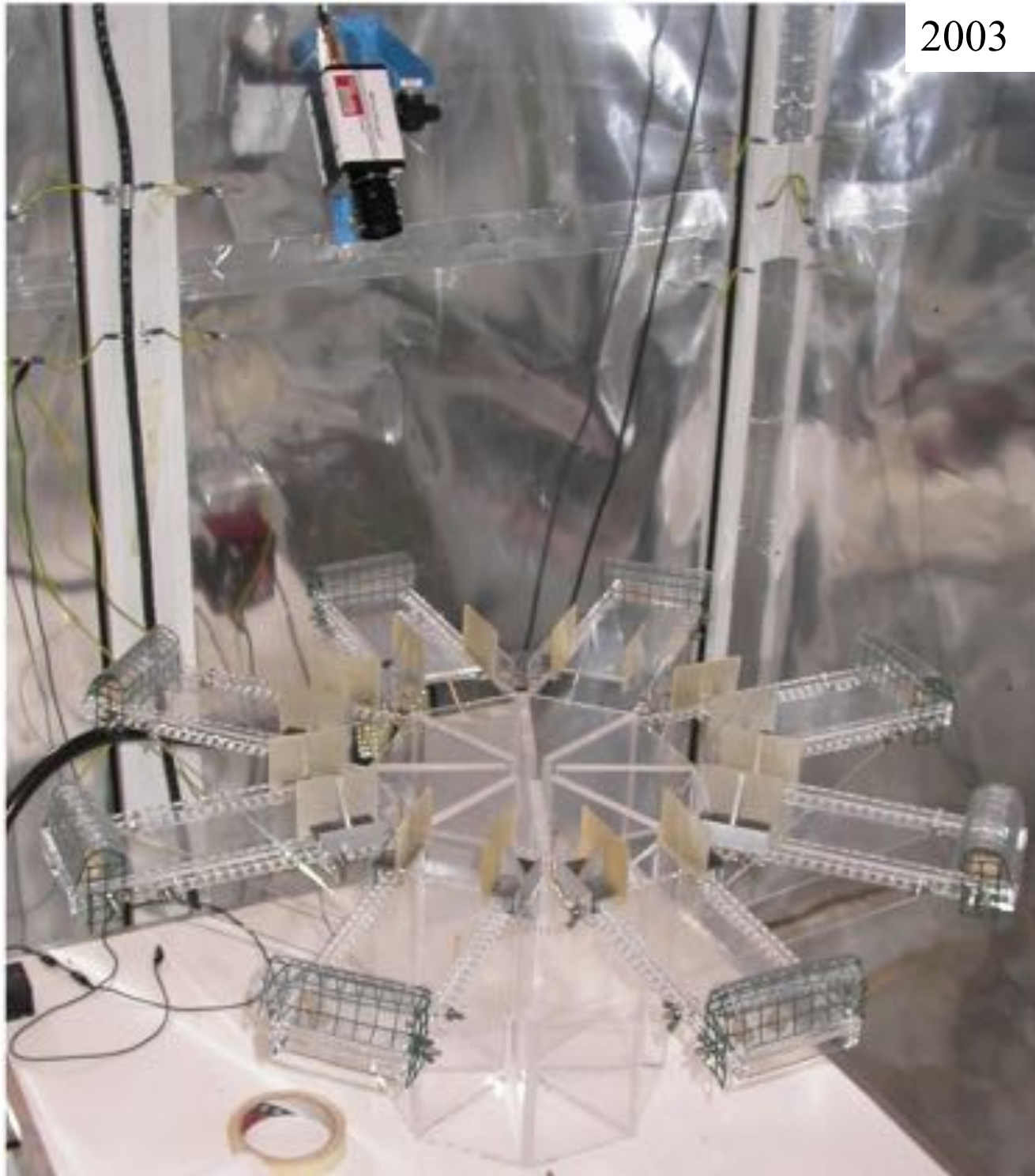

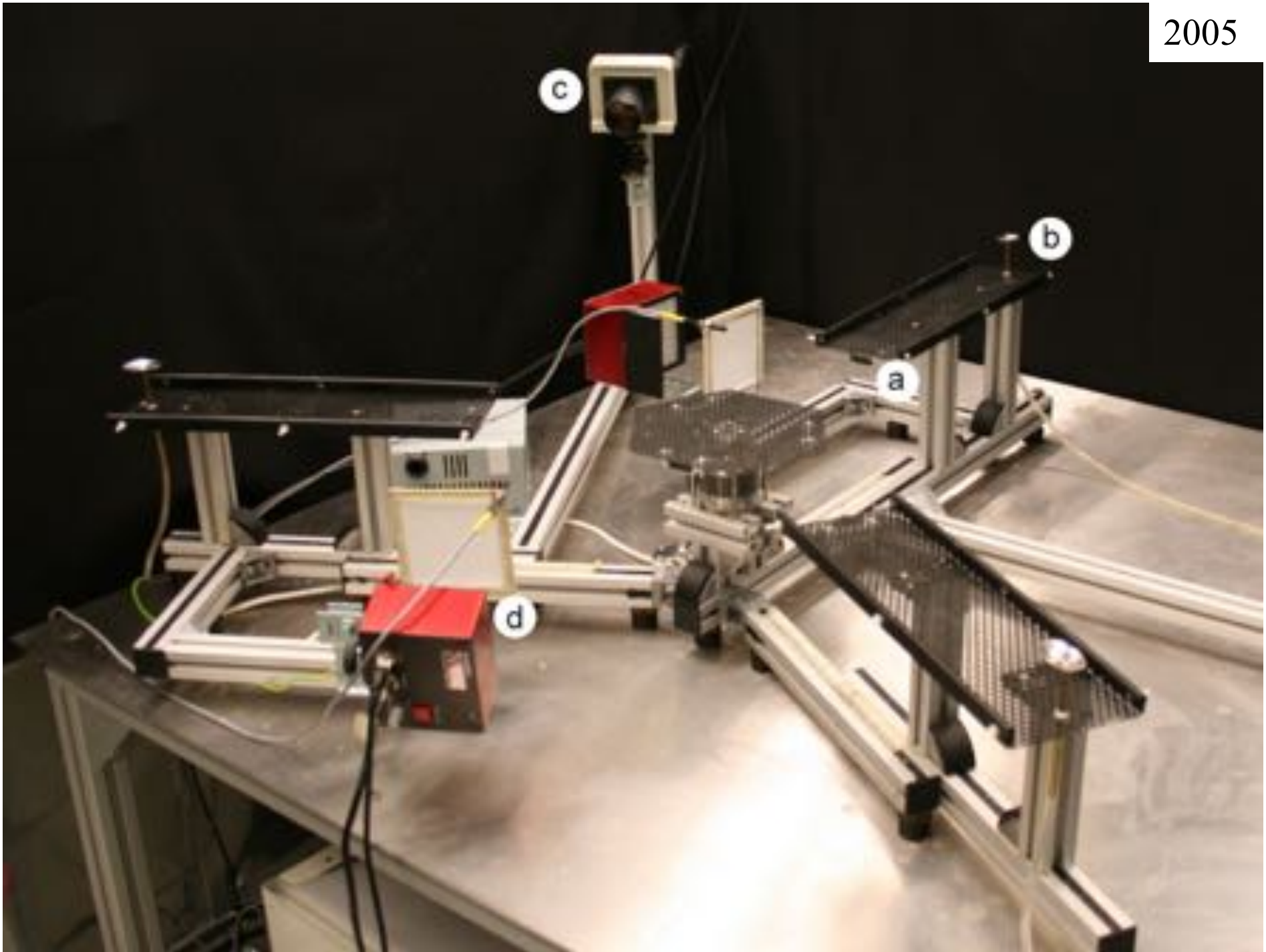

now



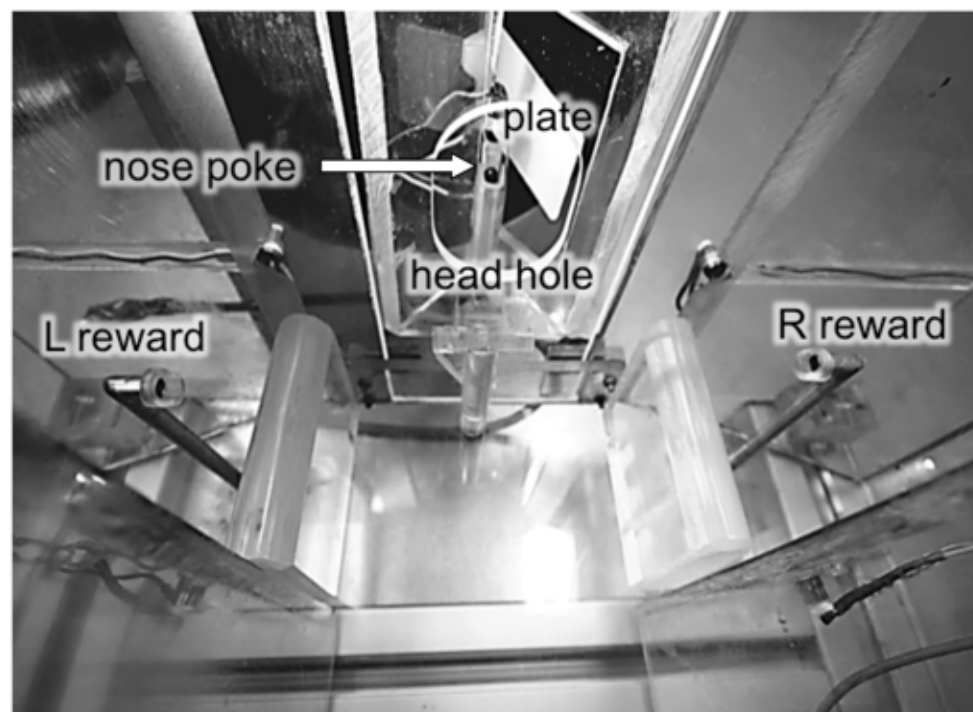
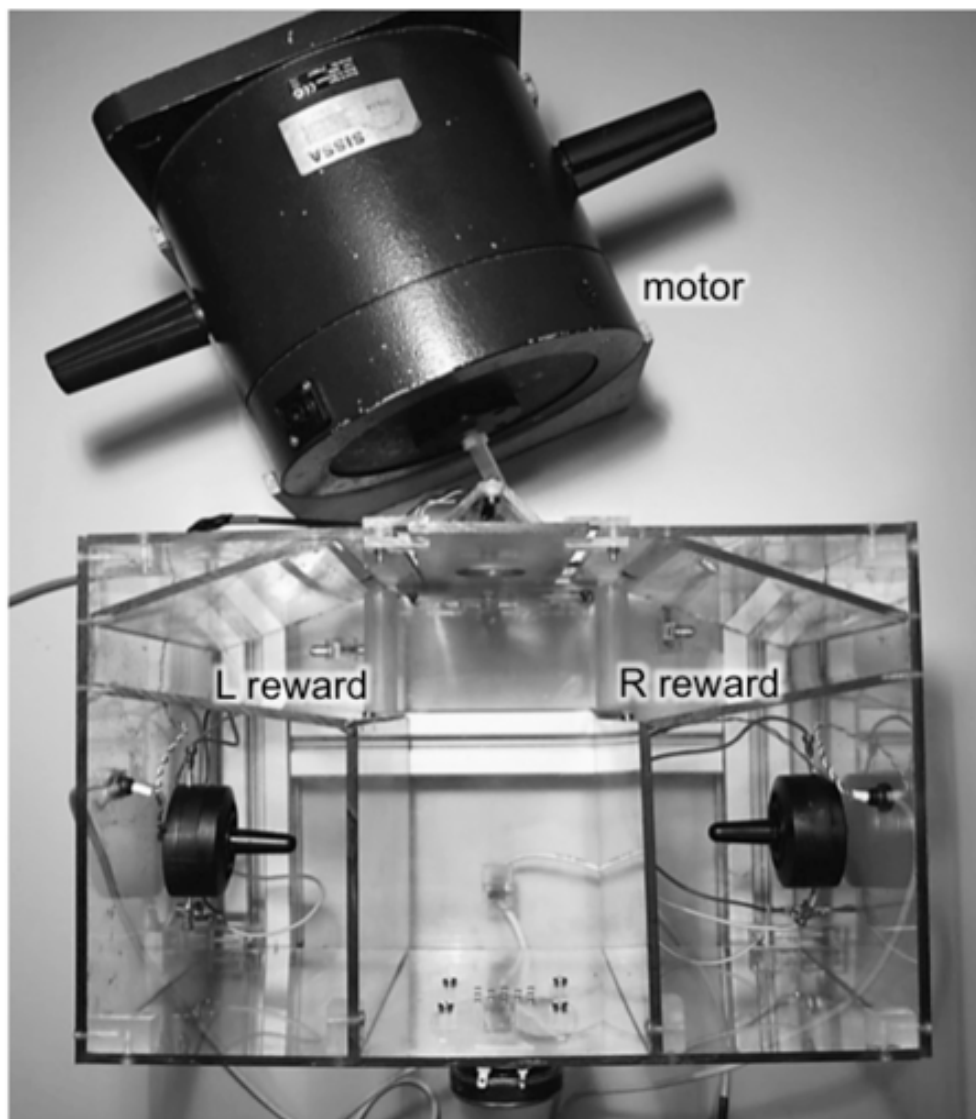

psychophysics

measuring neuronal activity

building an apparatus

 monitoring behavior

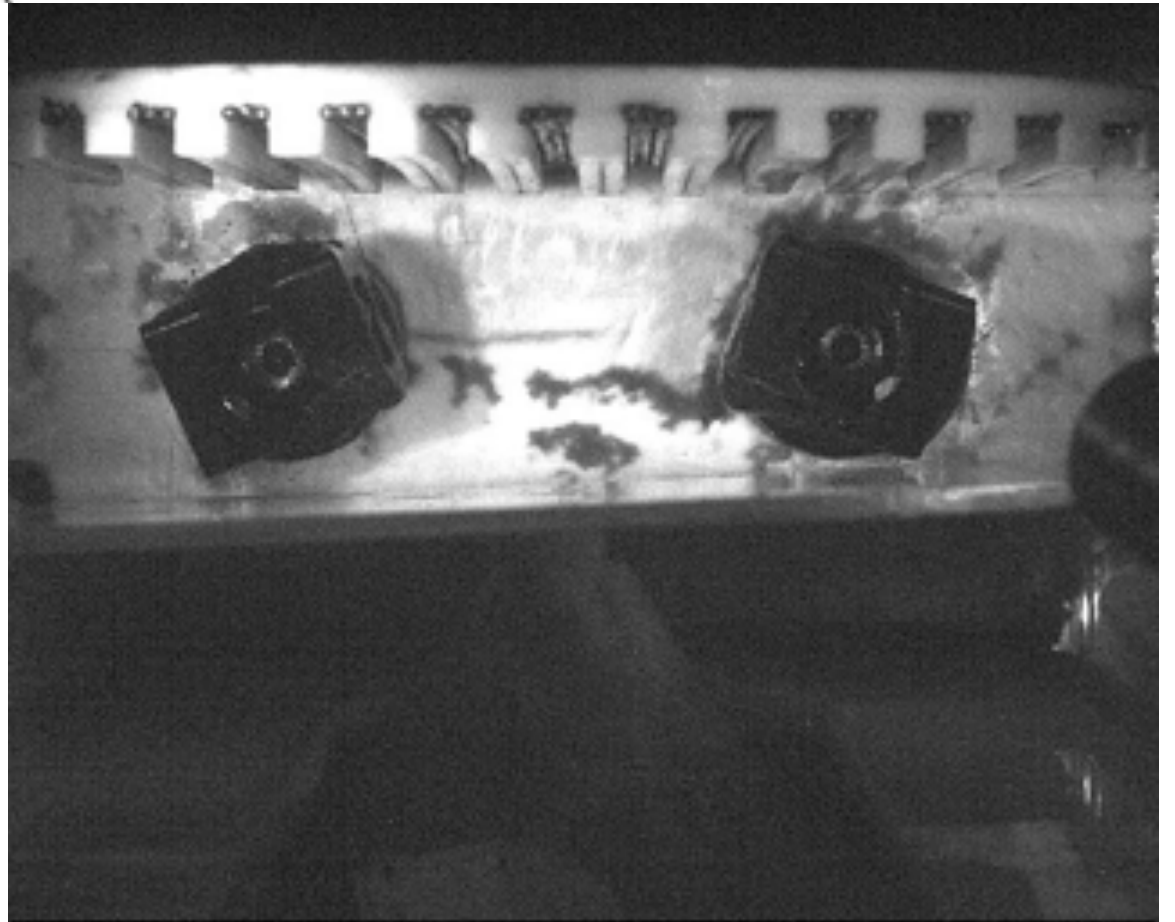
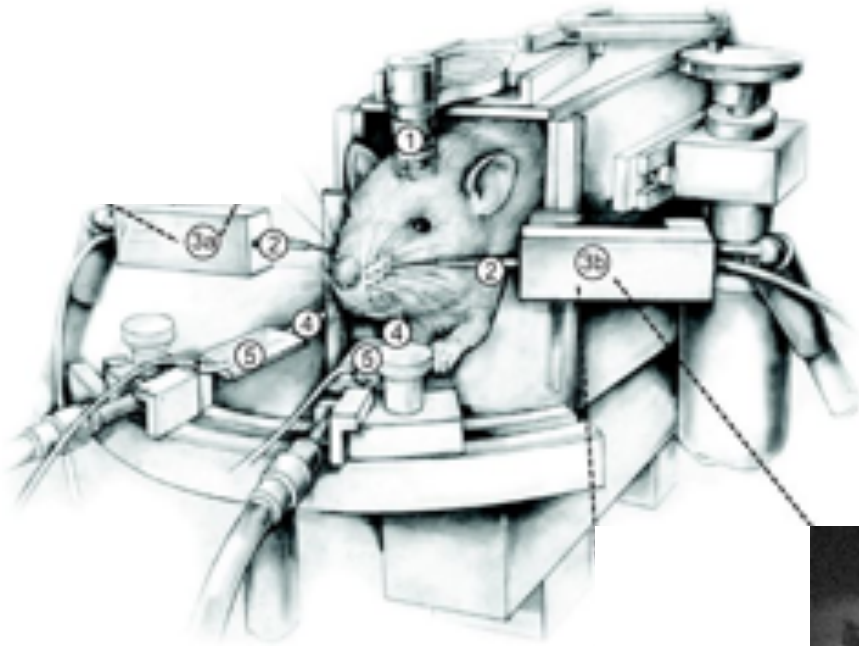

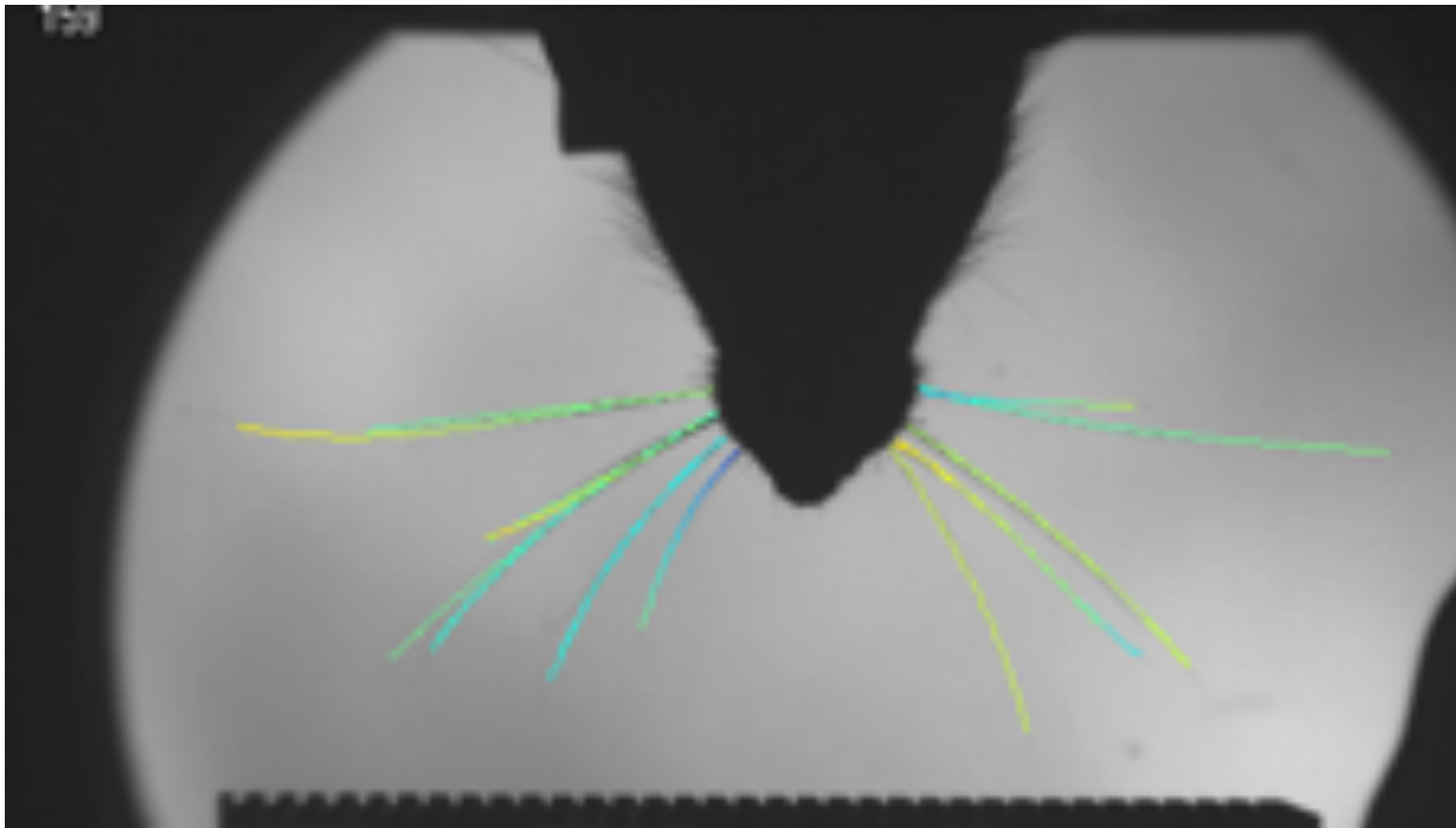

local curvature

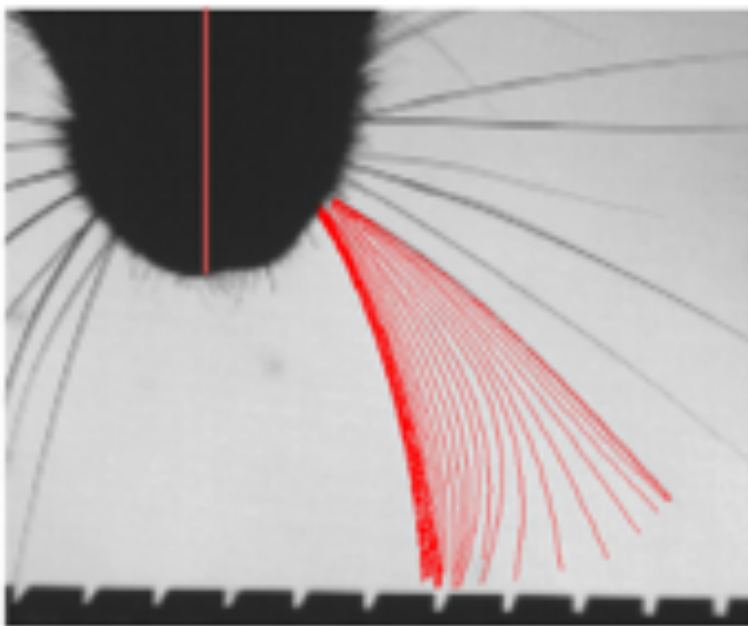
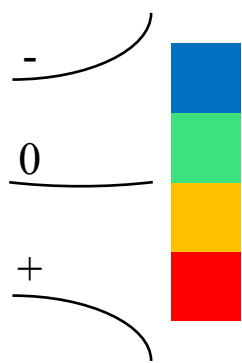

snout

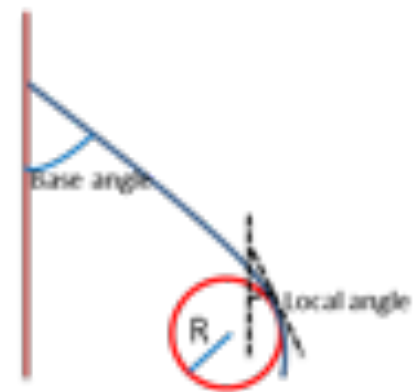

$$\text{Curvature} = \frac{1}{R}$$

Today's methods



Sebastian Reinartz
SISSA postdoc

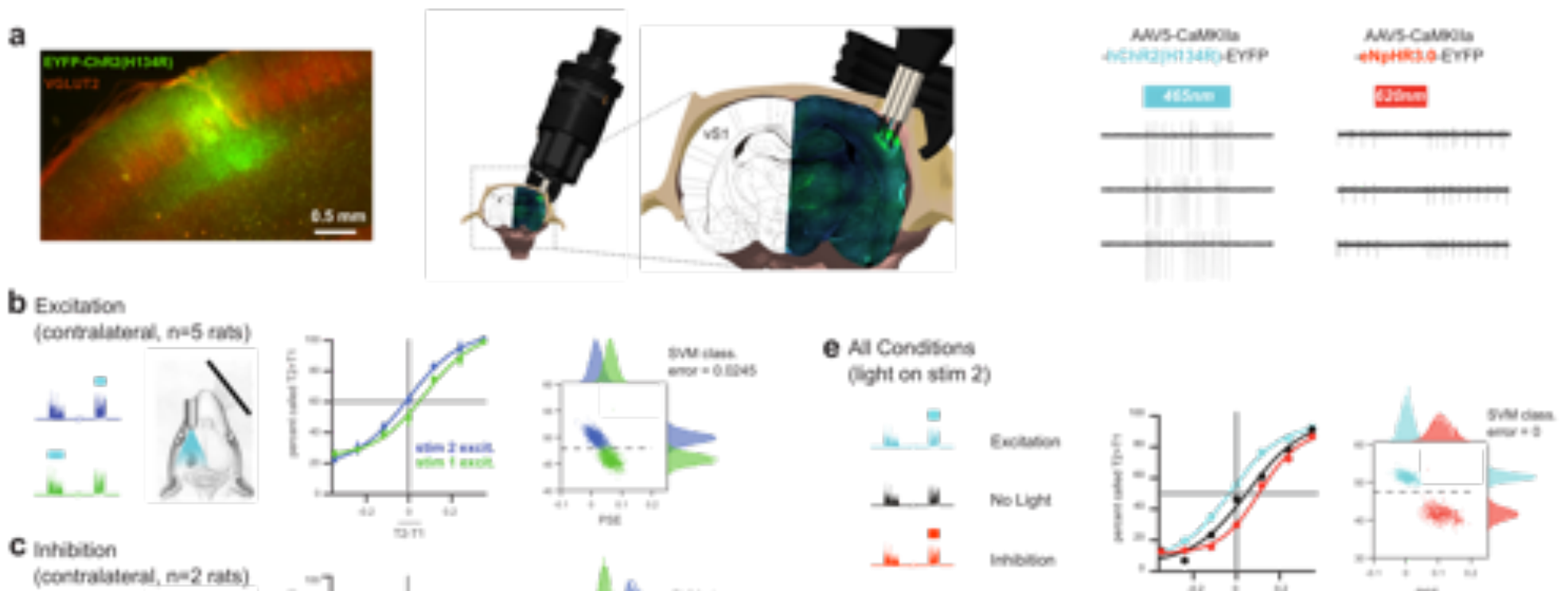



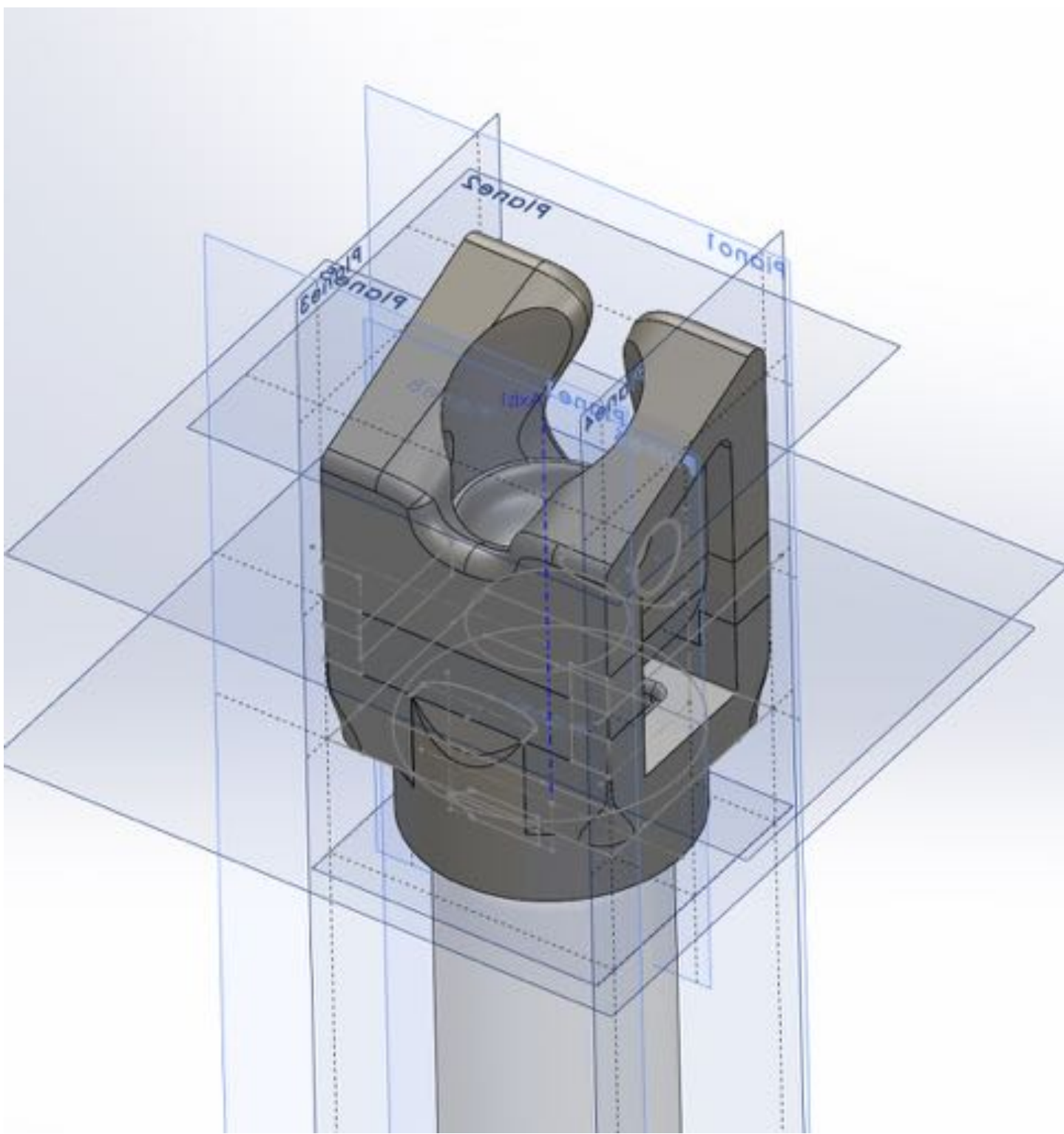

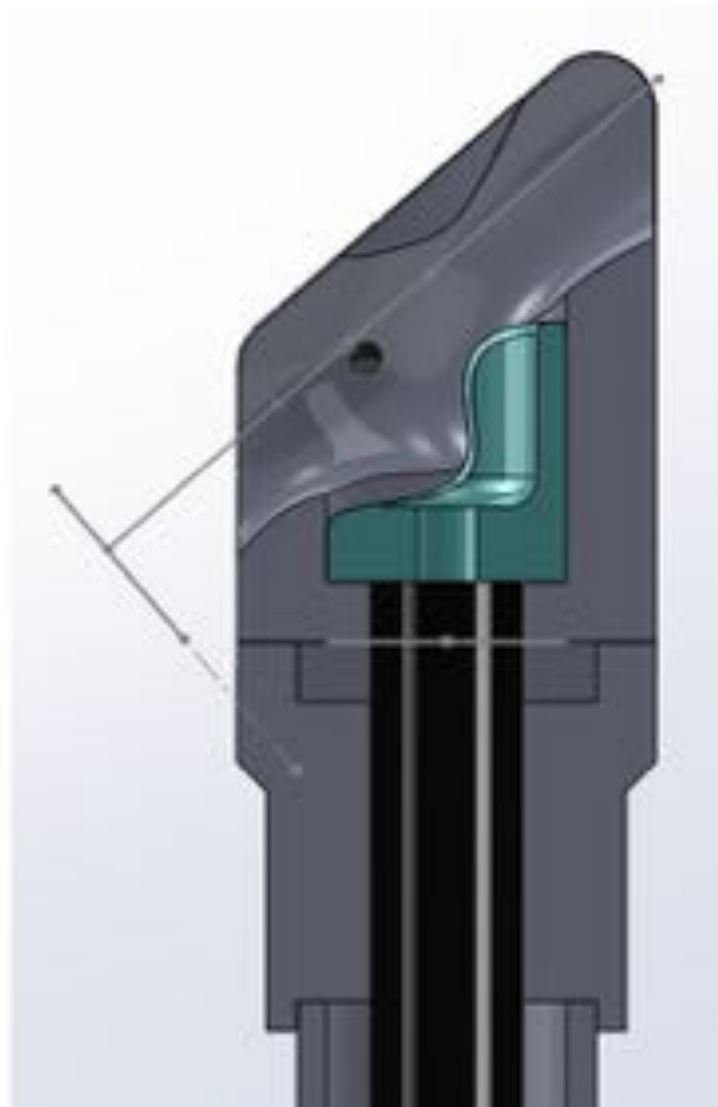
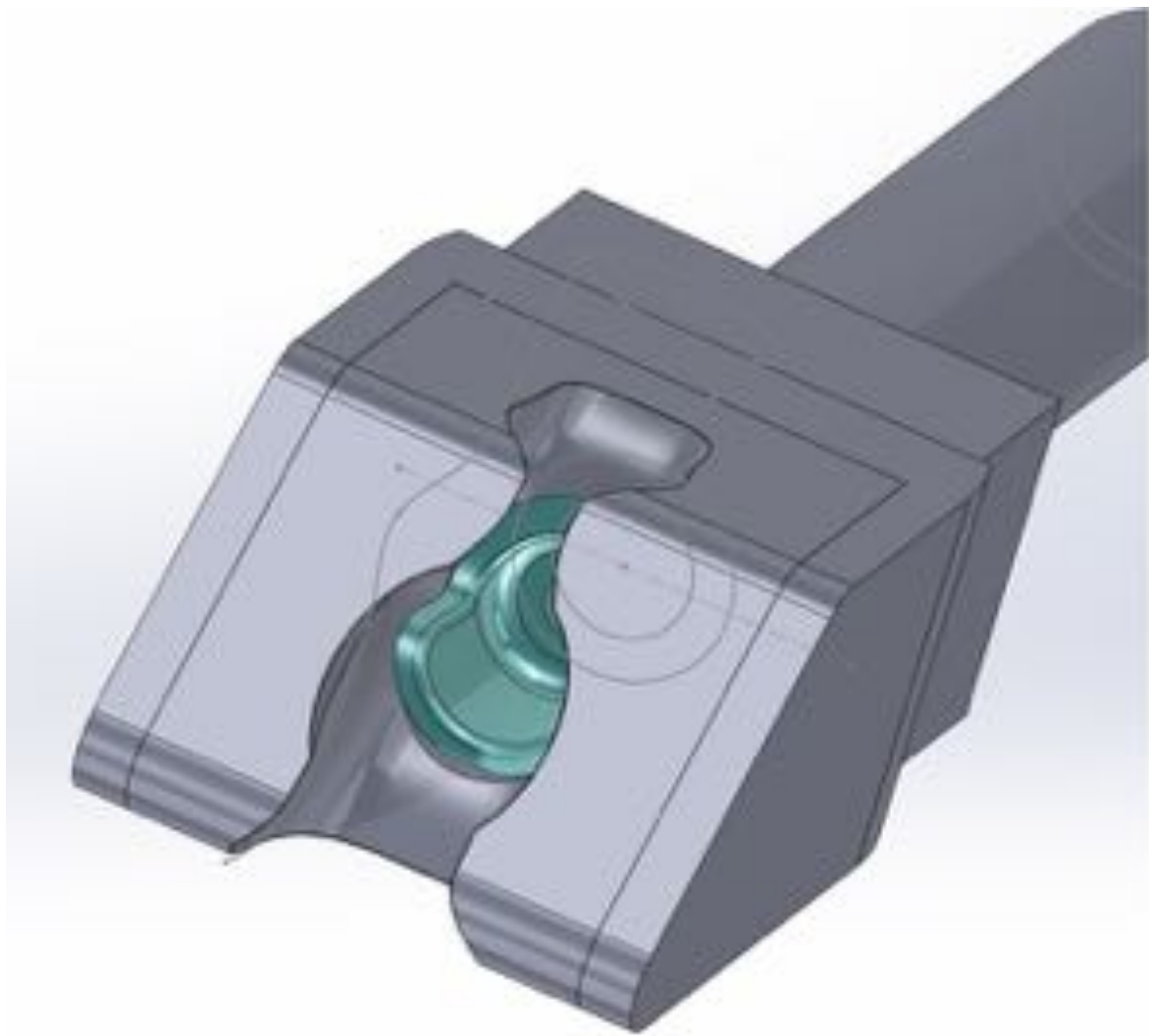

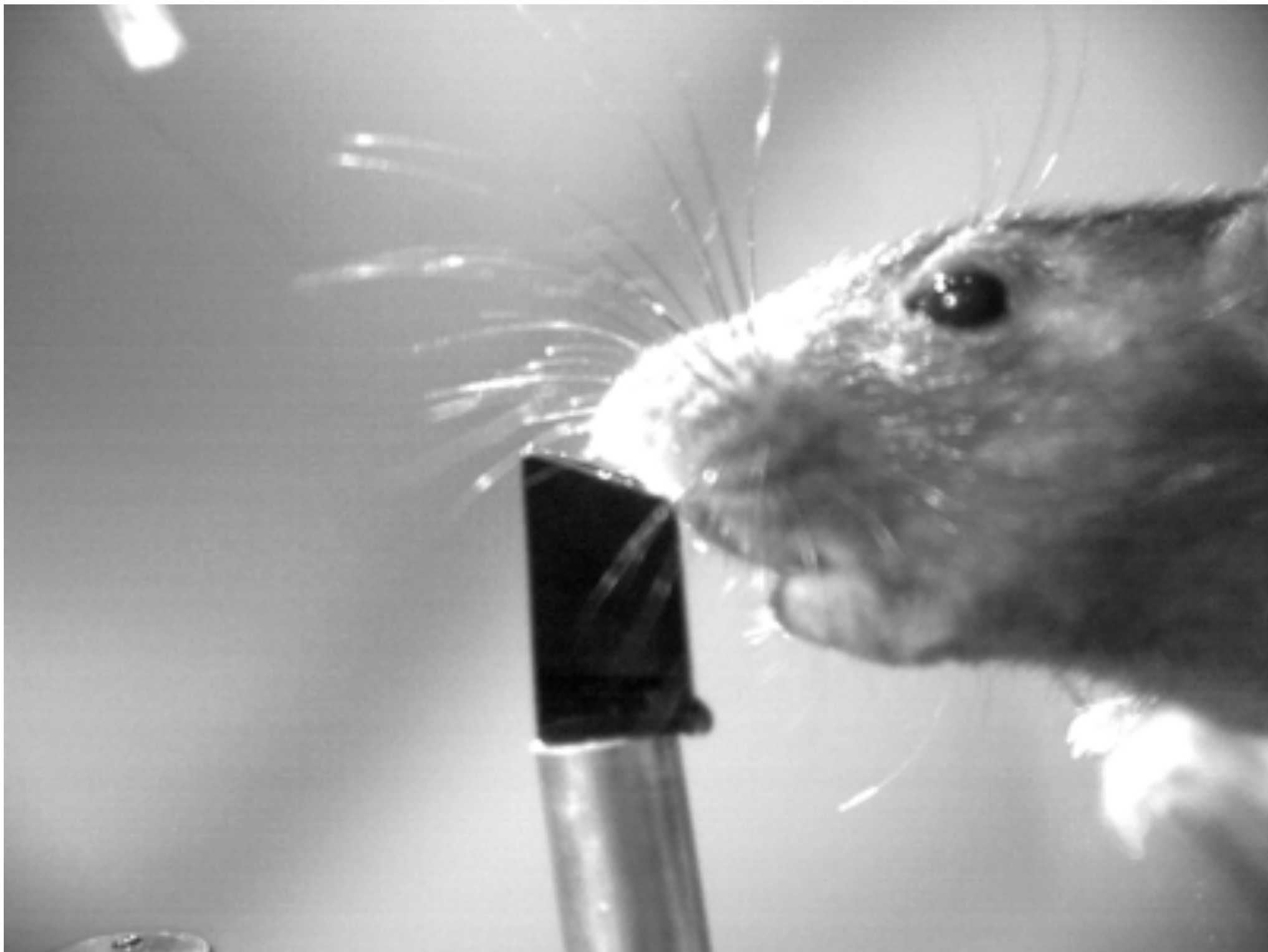



behavioral neuroscience:

To quote from the underrated film «Galaxy Quest»



OUR AIM: cognitive neuroscience of sensation and perception

