



LESSON 4.

Touch and (a bit of) pain

Aristotle listed the famous 5 senses, one of the “touch”.

yet modern neuroscience recognizes at least 4 modalities within somatosensation.

- (1) proprioception
- (2) tactile or touch (light mechanical stimuli)
- (3) pain (damaging stimuli)
- (4) thermal

Are they really distinct?

Well, yes and no. There can be selective deficits.

For example tabe dorsale (syphilis) can cause a rather selective proprioceptive deficit.

Specific spinal lesions of other sorts can also cause specific deficits

Surgical lesion for chronic pain

Section of skin showing the morphology and position of tactile receptors. This figure refers to “glabrous” skin (meaning hairless, e.g. skin of the palms) in primates.

The mechanoreceptive nerve membrane is sheathed in various accessory organs!

The Meissner corpuscle, Pacinian corpuscle, Ruffini corpuscle, and Merkel disk are all specialized structures that filter the mechanical energy that excites the nerve termination. The free nerve endings are, as the name implies, uncovered, exposing them to substances released by the skin tissues.

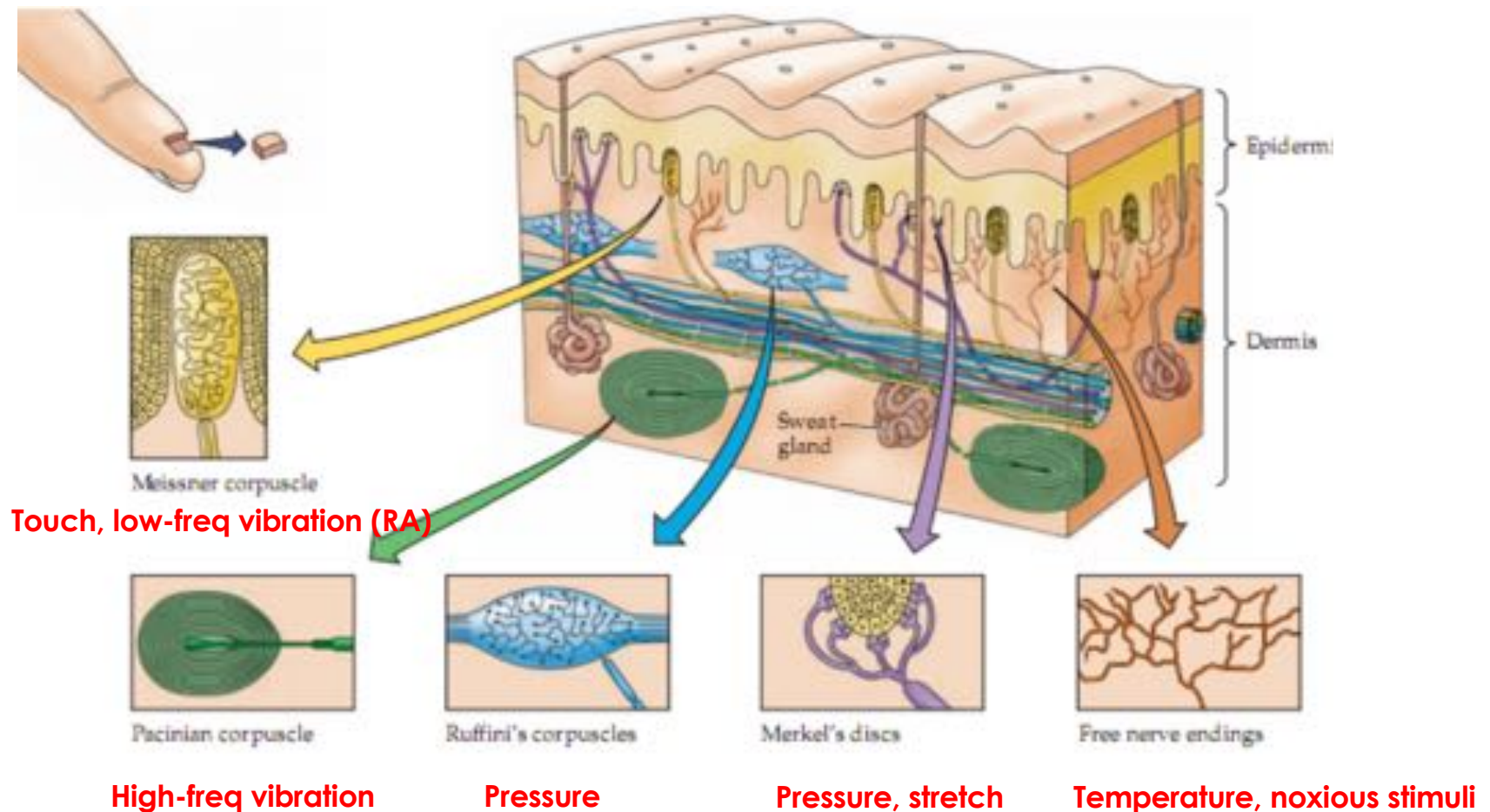

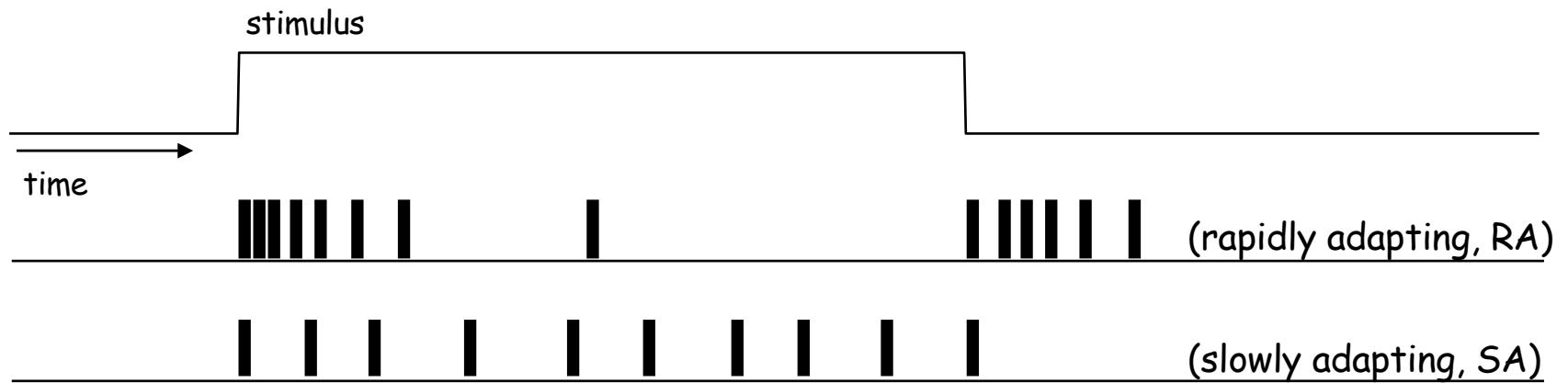

Receptor

Sensitivity

Pacini

vibration, $f > 50-400\text{Hz}$

RA

Meissner

vibration, $f < 50\text{Hz}$

RA

Merkel

pressure, stretching (superficial)

SA

Ruffini

pressure, stretching (deep)

SA

Hair follicle

hair motion

various



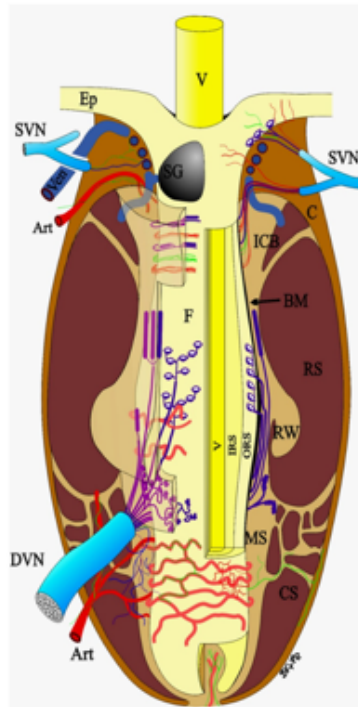
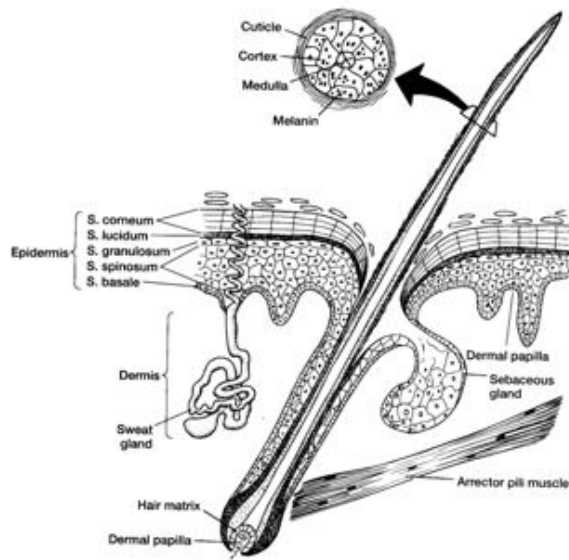

Free termination

thermal, noxious

SA, but also sensitizing



Myelinated Mechanoreceptors:

-  Transverse lanceolate endings
-  Merkel cells and endings
-  Lanceolate endings
-  Reticular endings
-  Fuzzy endings
-  Club endings

- | | | |
|------------------------|--------------------------|----------------------|
| Art = arteriole | GH = guard hair | RW = ringwulst |
| BM = basement membrane | ICB = inner conical body | SG = sebaceous gland |
| C = FSC capsule | IRS = inner root sheath | UD = upper dermis |
| CS = cavernous sinus | MS = mesenchymal sheath | V = vibrissa |
| Ep = epidermis | ORS = outer root sheath | VH = vellus hair |
| F = follicle | RS = ring sinus | |

Hair follicles.

Schematic view of a hair shaft and follicle from the skin of a primate. Nerve terminations are distributed throughout the follicle, and wrapped around the base of the hair, generating impulses for any hair movement. The muscle contracts to erect the hair in response to cold or arousal.

Schematic view of a special hair follicle, that of the large whisker of the snout of a rat or mouse. Nerve terminations occupy many different locations within the follicle, and their positioning is likely to be closely related to type of hair movement that excites them (vibration, bending, pulling etc.).

you

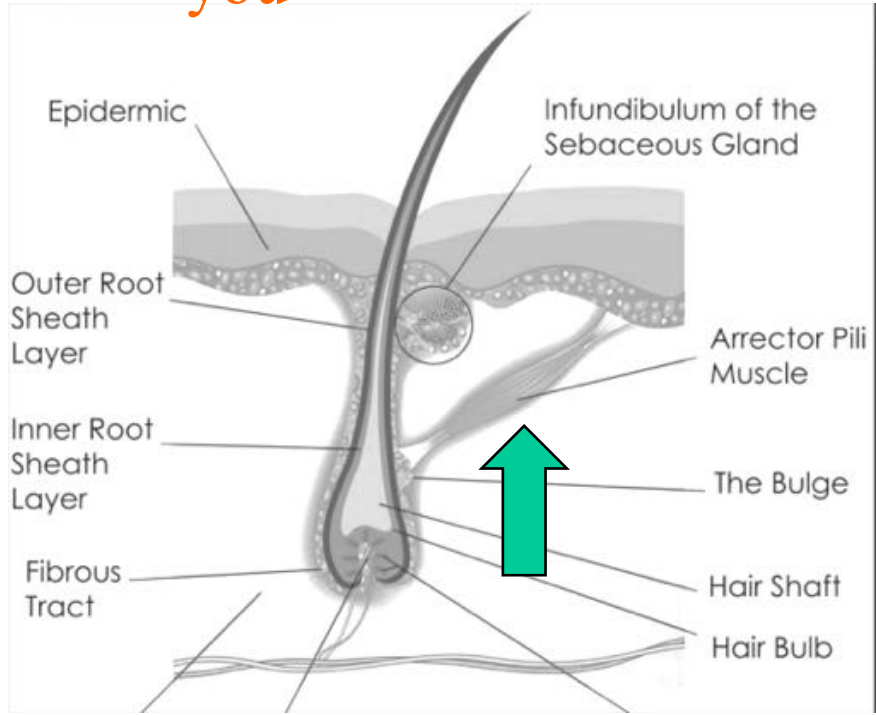

rat

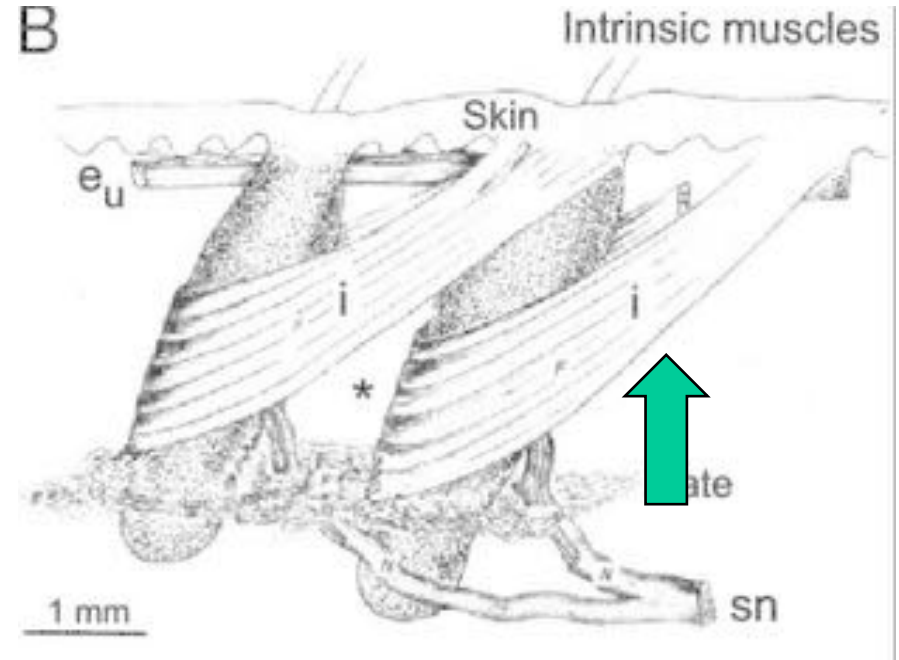



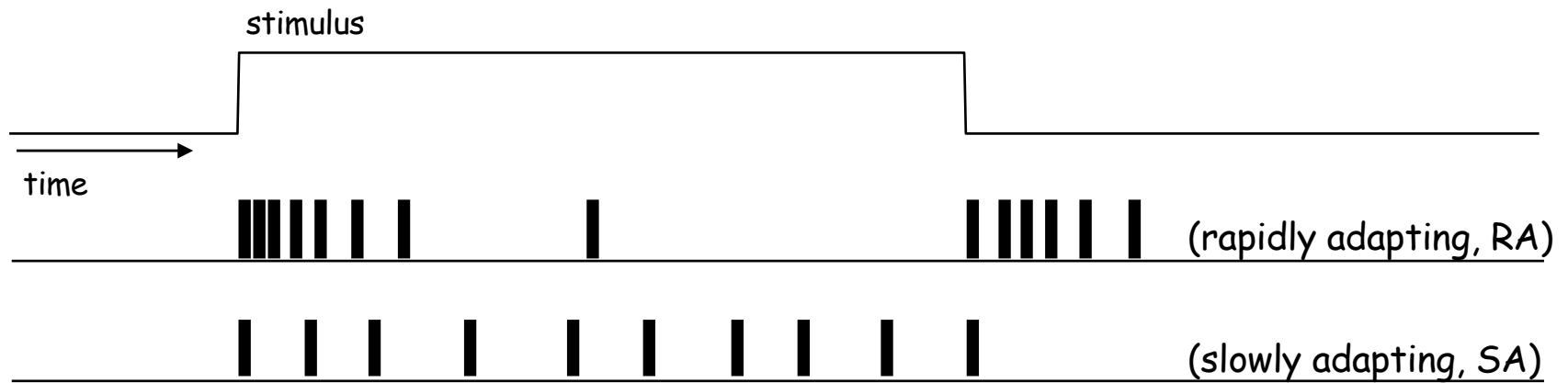

Receptor	Sensitivity	Adaptation
Pacini	vibration, $f > 50-400\text{Hz}$	RA
Meissner	vibration, $f < 50\text{Hz}$	RA
Merkel	pressure, stretching (superficial)	SA
Ruffini	pressure, stretching (deep)	SA
Hair follicle	hair motion	various
Free termination	thermal, noxious	SA, but also sensitizing

Experimental subjects (animals) in lab... what about us?

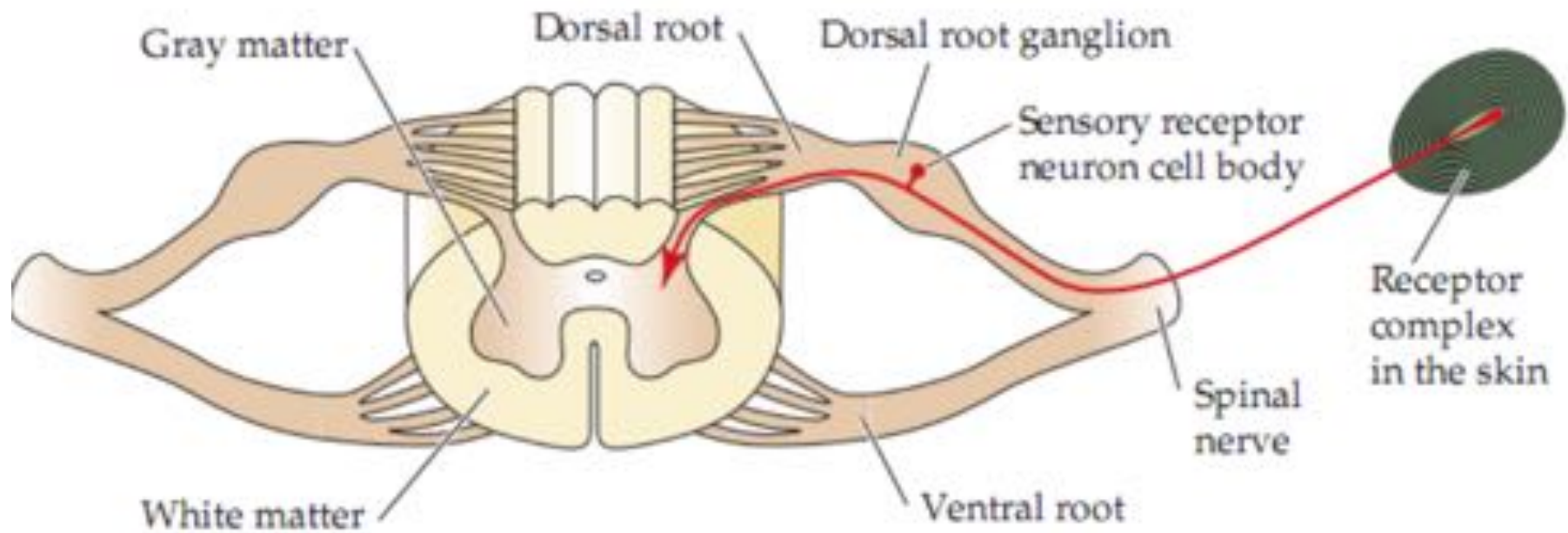

Morphology of sensory receptor neurons. The cell body that lies in a dorsal root ganglion situated in the aperture between the vertebrae of the spine. A central branch that joins a dorsal root and projects into the spinal cord, and a peripheral branch that joins other fibers in a peripheral nerve and then terminates as a specialized cutaneous receptor.

... What if we measure the signals of individual receptors as they travel towards the spinal cord in the peripheral nerve.



What we find is the amazing relationship between single fibers and sensation!

The microneurographic technique

Åke Vallbo & Karl-Erik Hagbarth, 1967

Thin ($200\ \mu\text{m}$) tungsten electrode in contact with a single afferent nerve fiber

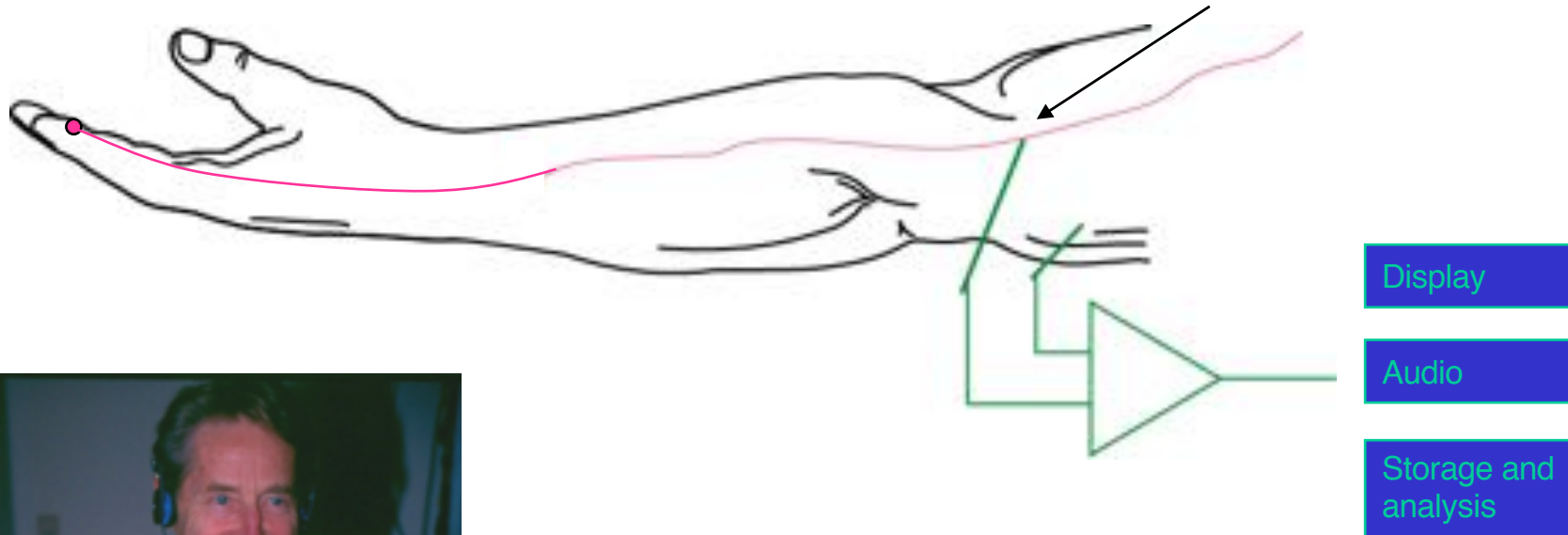

Activation of a receptor



The microneurography experiment



The microneurography experiment



The microneurography experiment



Single unit recording

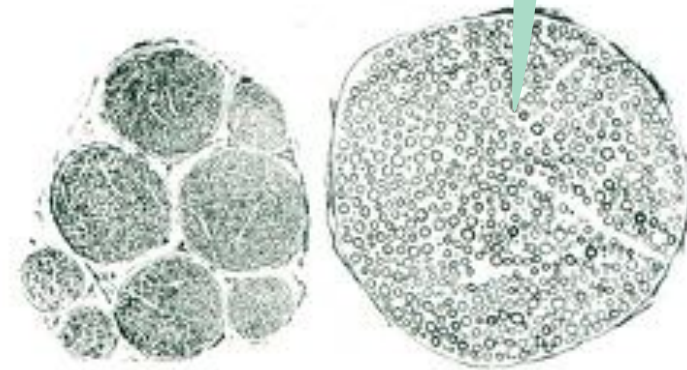
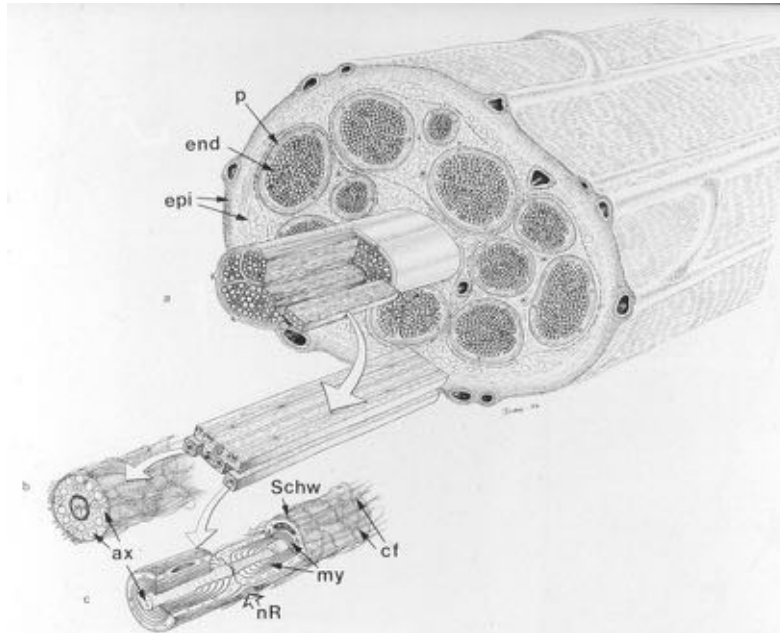
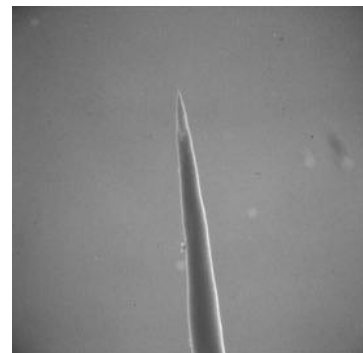

FIG. 1. Cross-section of the rat superficial radial nerve at original magnification of 45 \times (left) and 112.5 \times (right). All the nerve bundles composing the superficial radial nerve are shown on the left, and one bundle is enlarged on the right. Part of one bundle is shown below at magnification of 450 \times .



Thin (200 μm) tungsten electrode
in contact with a single nerve fiber

Vallbo e Johansson –

Receptive fields of Meissner receptors (sensitive to pressure and vibration)...

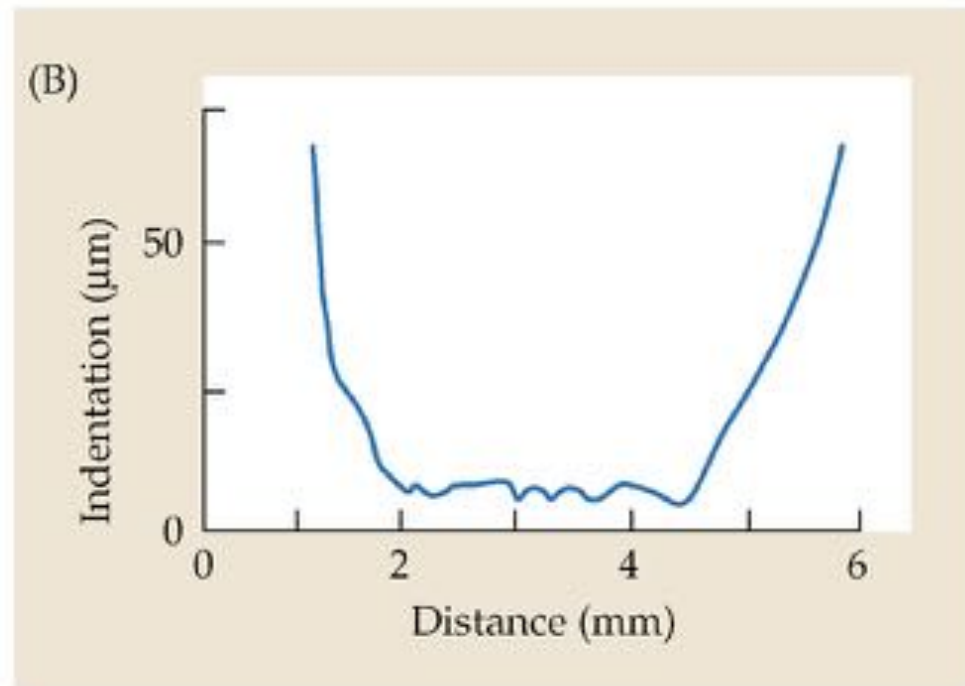

Low-Threshold Mechanoreceptors (LTMs) in the hand

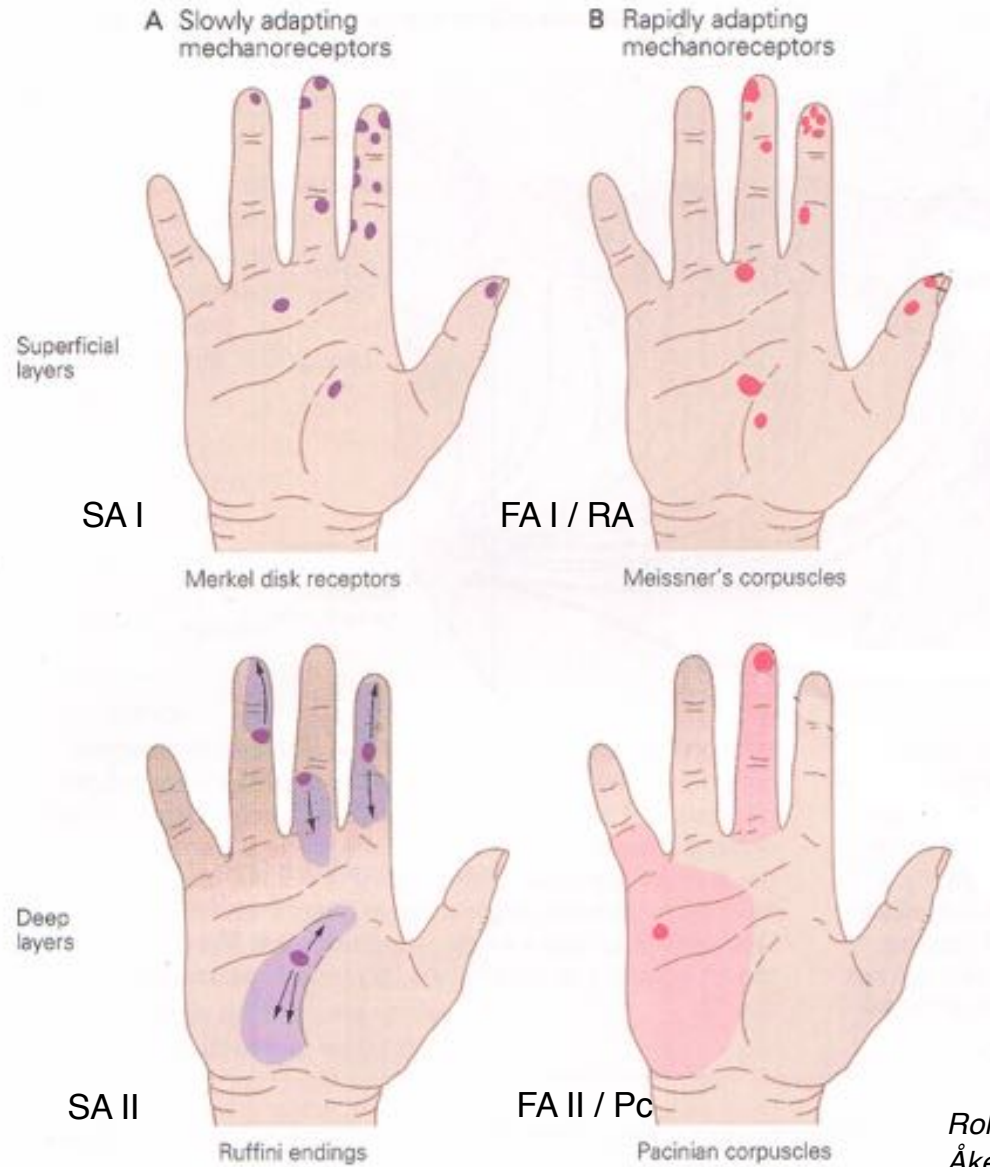

Slowly adapting

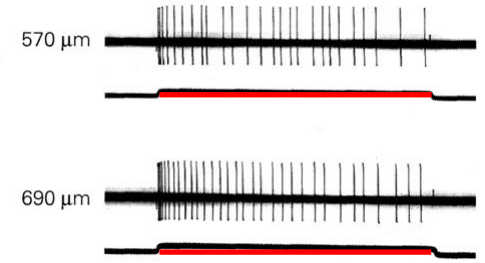

Rapidly adapting

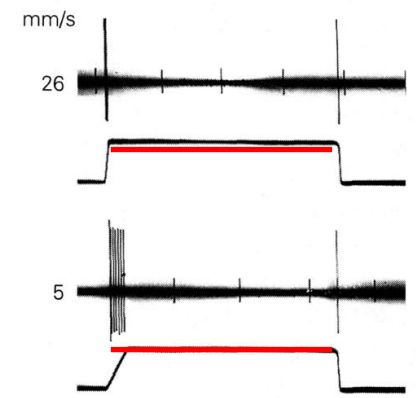

Roland Johansson; Umeå
Åke Vallbo; Umeå, Göteborg

Intraneural microstimulation (INMS)

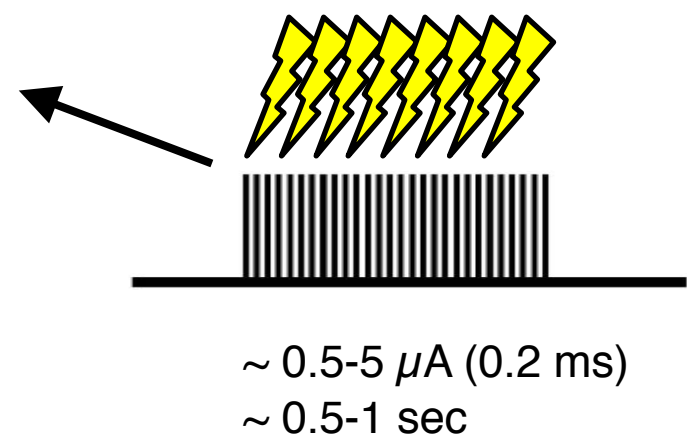
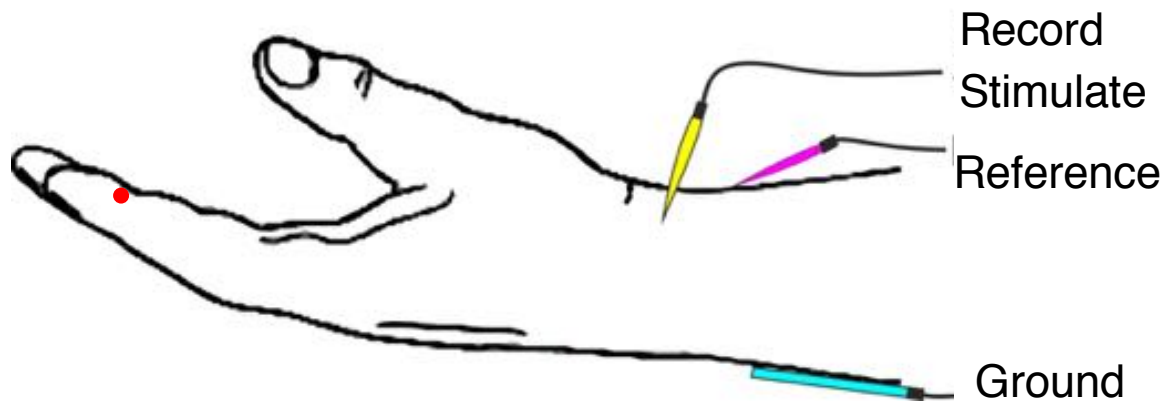
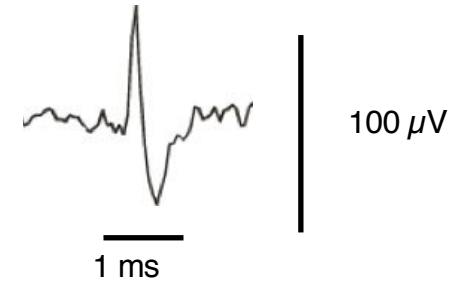
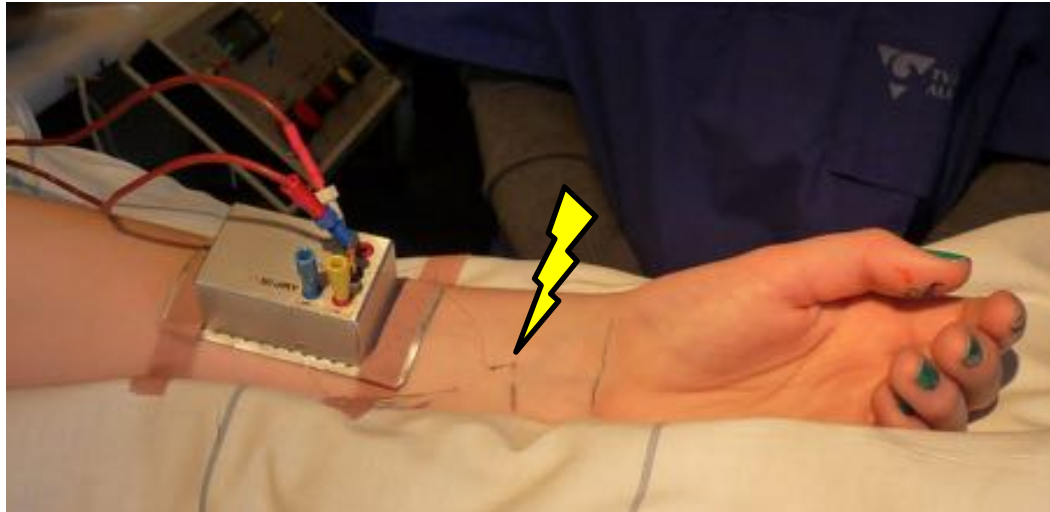

Intraneural microstimulation (INMS) of single afferents

- Trains of stimuli (or single shocks, FA I) give rise to localized, precise sensations of touch
- Median threshold 0.8 μA (0.2 ms) (range 0.3 – 5.5 μA)

Vallbo et al, 1984, Brain

von Frey hair to map the receptive field



Perceived position

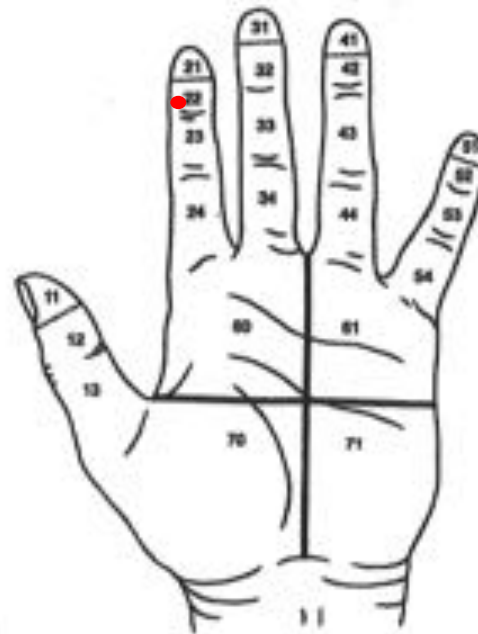

Perceived size

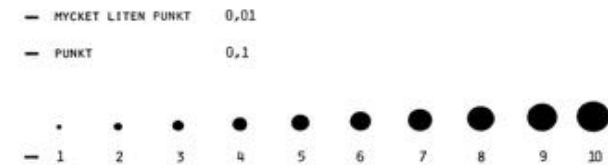

Perceived shape



Perceived borders



Intraneural microstimulation (INMS) of single afferents

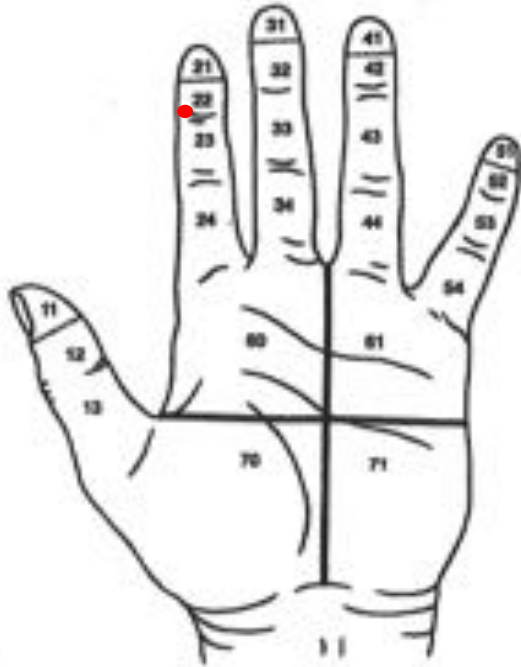

Reported sensations are specific for each LTM class

- FAI point of tingling vibration (frequency dependent)
- SAI sustained point of pressure (or "pulling") sensation
- Pc vibration
- SAI no sensation

Single-unit stimulation?

- ~12 published papers on LTM INMS
Torebjörk & Ochoa (1980, *Acta Phys Scand*),
Vallbo (1981, *Brain Res*), Vallbo et al (1984, *Brain*).
- Debate: Wall & McMahon (1985, *Pain*) vs.
Torebjörk, Vallbo & Ochoa (1987, *Brain*)
- Unitary and "quantal" nature of sensation
- Distinctive, highly reproducible, sensations for the different classes (*cf. above*)
- Lowest threshold with positive polarity
(= electrode tip at internode,
on/in myelin sheath of a single fiber)

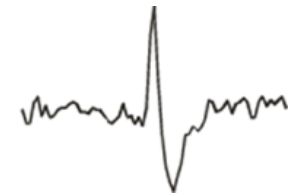

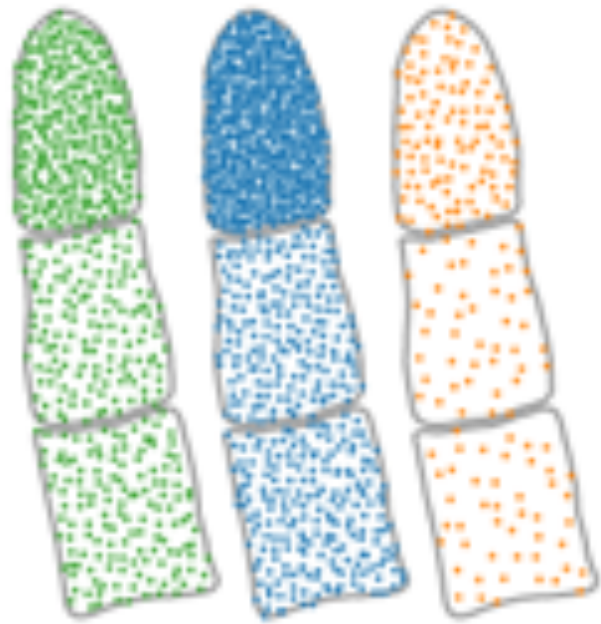
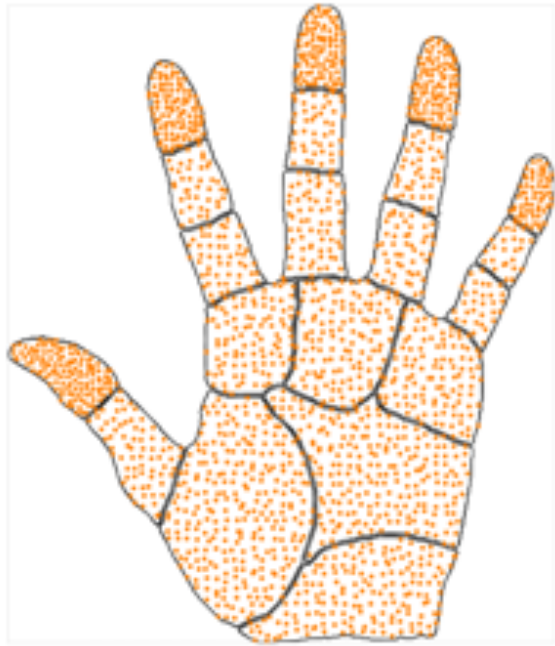

SA1

RA

PC

Cortical responses during microstimulation of single afferents

Trullsson et al.,
Neuroimage 2001, 13, 613-22

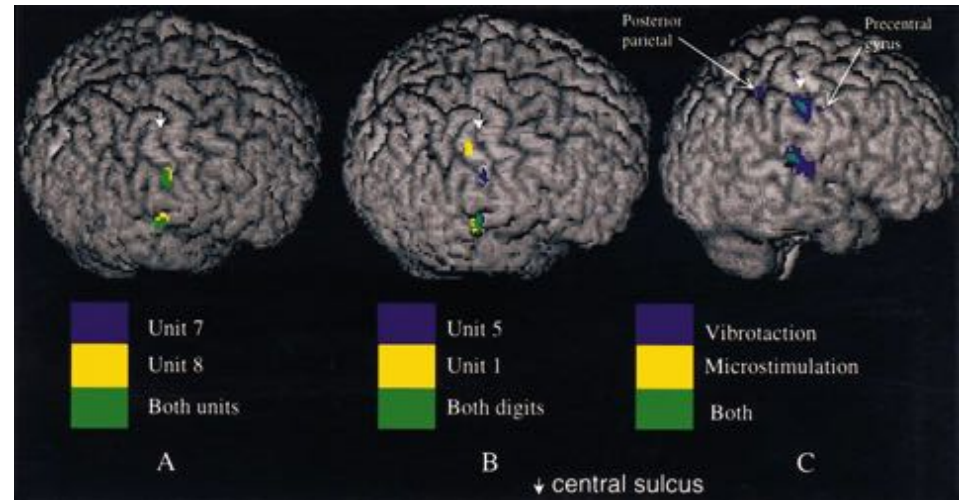
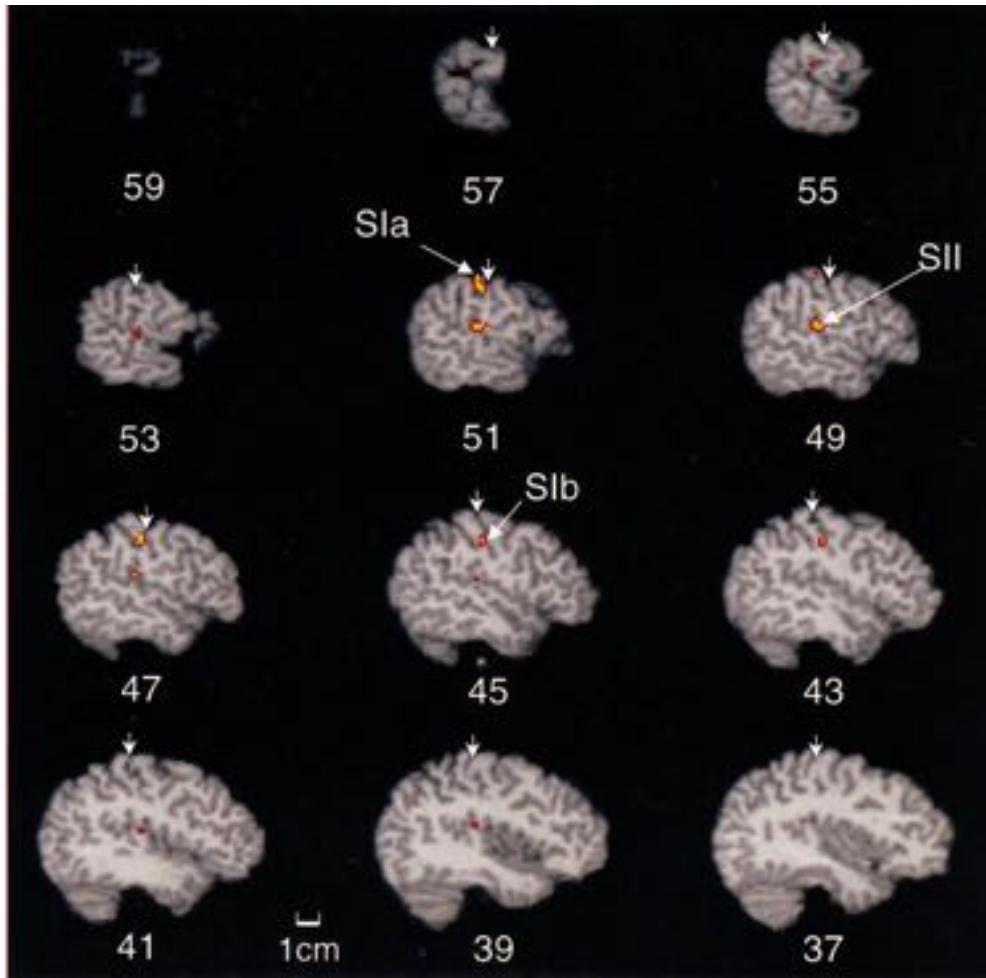

- 8 single afferent units (4 SA I, 4 FA I)
- small, local activations in S-I and S-II

1. Receptive field of a fiber in human subject is similar to “experimental” subject.
2. Tactile stimulation confirms submodality specificity.
3. Electrical stimulation of fiber confirms the equivalence between fiber activity and sensation.
4. The system has very low “noise”

Well, what about painful stimuli?

Just a very strong activation of “touch” receptors?

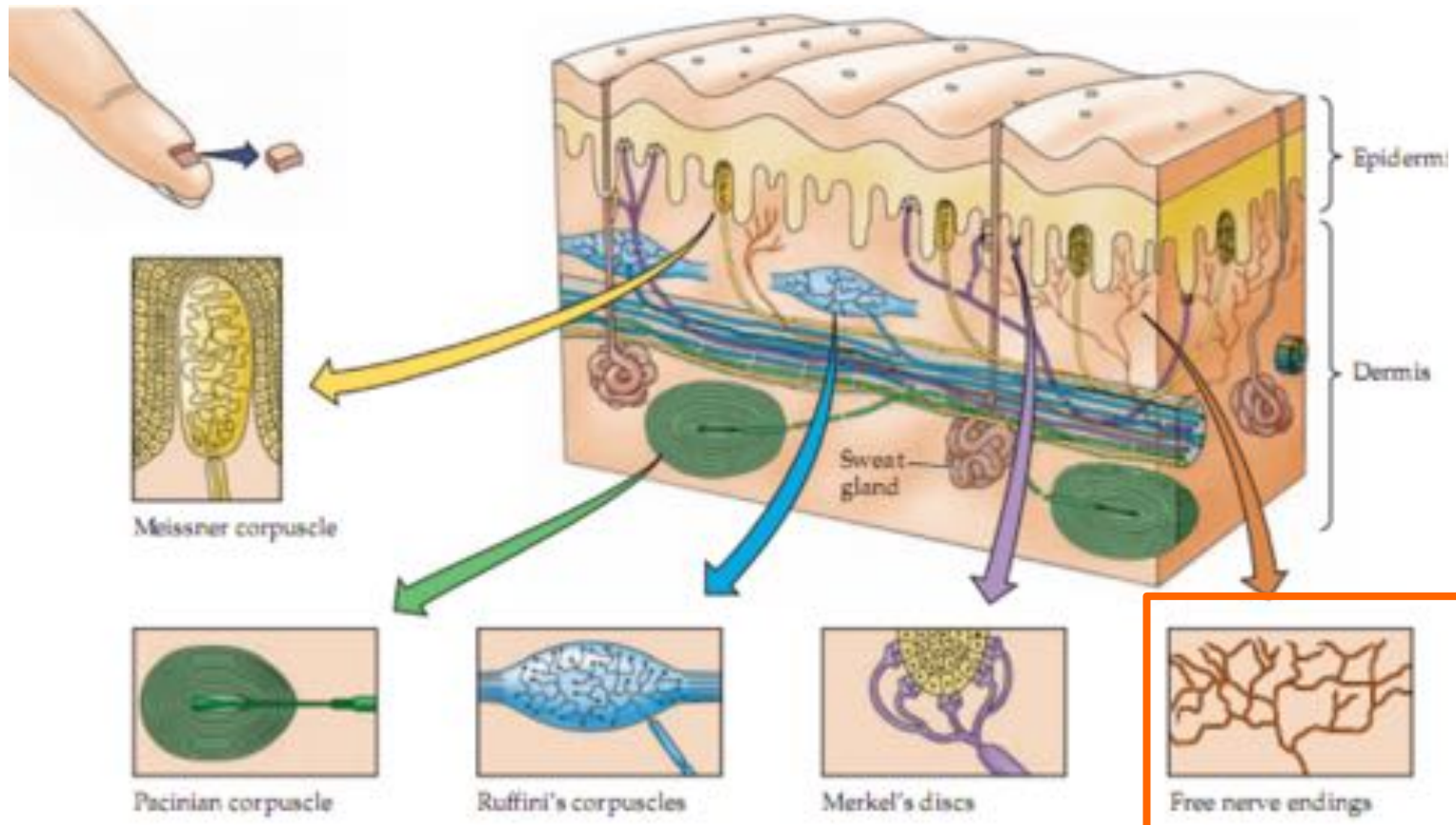

Free nerve endings

Temperature, noxious stimuli

The discovery of a separate population of nociceptors – which correspond to C fibers – together with the finding that low-threshold mechanoreceptors do not respond to painful stimuli, ruled out an earlier theory that pain results from the excessive mechanoreceptor stimulation.

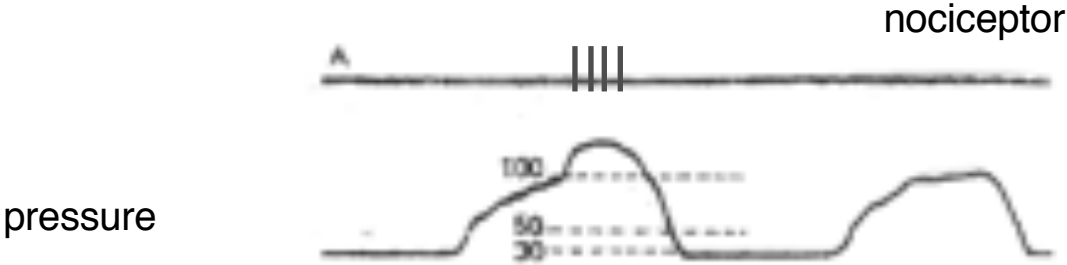

Nociceptors are mechano-chemical receptors

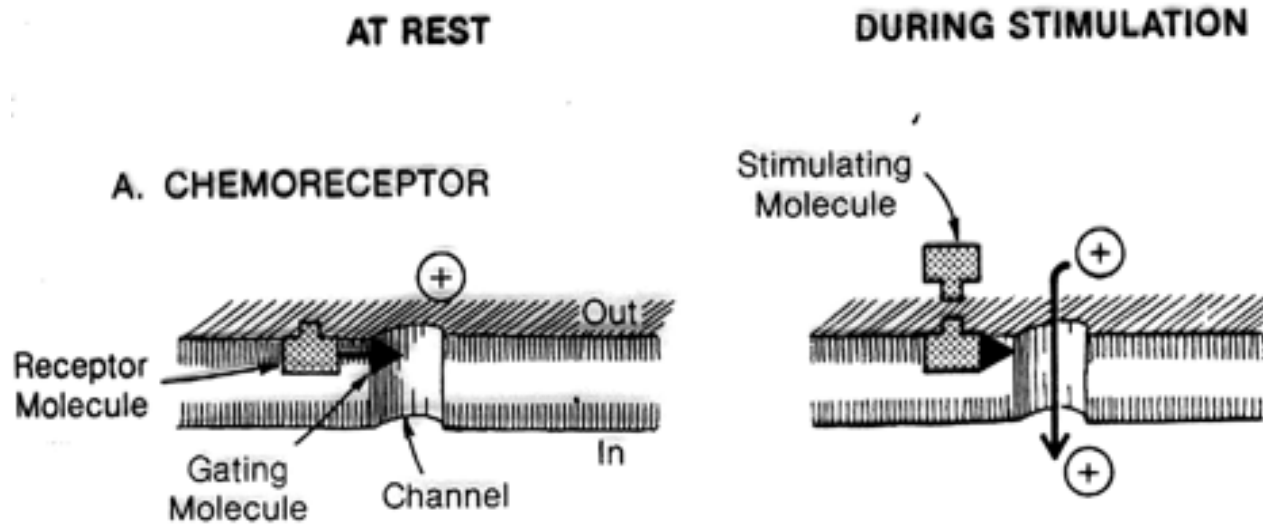

Temperature changes are transduced by free nerve endings-through the activation of Transient Receptor Potential (TRP) ion channels. Channel permeabilities vary with changes in skin temperature. Four different TRP channels, TRP-V1 to TRP-V4, are activated over different warm temperature ranges.

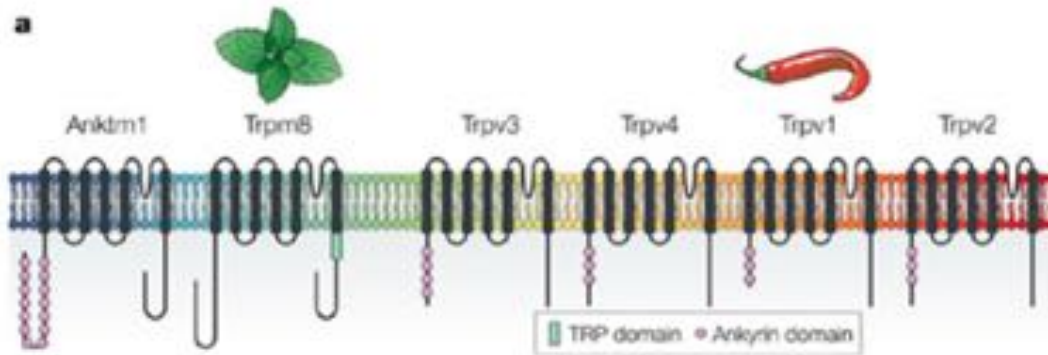

TRP-V1 is activated by noxious heating, and is sensitive to capsaicin. TRP-M8 is a Ca²⁺ permeable channel activated by lowering temperature. Menthol and eucalyptol also activate this channel, which explains the “cooling” sensation evoked by these compounds.

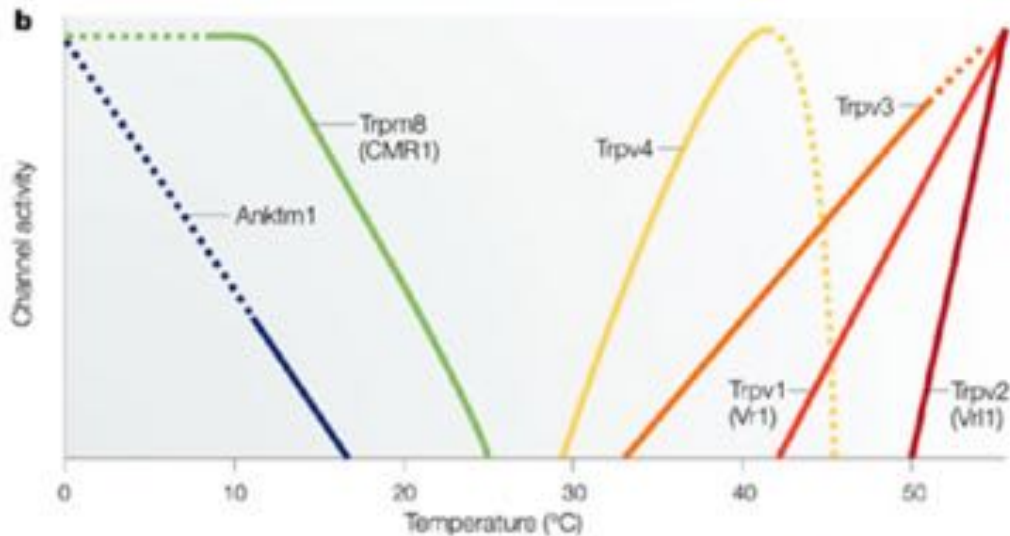

Patapoutian et al. 2003

Nature Reviews | Neuroscience

Nociceptors

- ▶ Nociceptors are special receptors that respond only to **noxious** stimuli and generate nerve impulses which the brain interprets as "pain"
- ▶ Free nerve endings
- ▶ Tissue damage

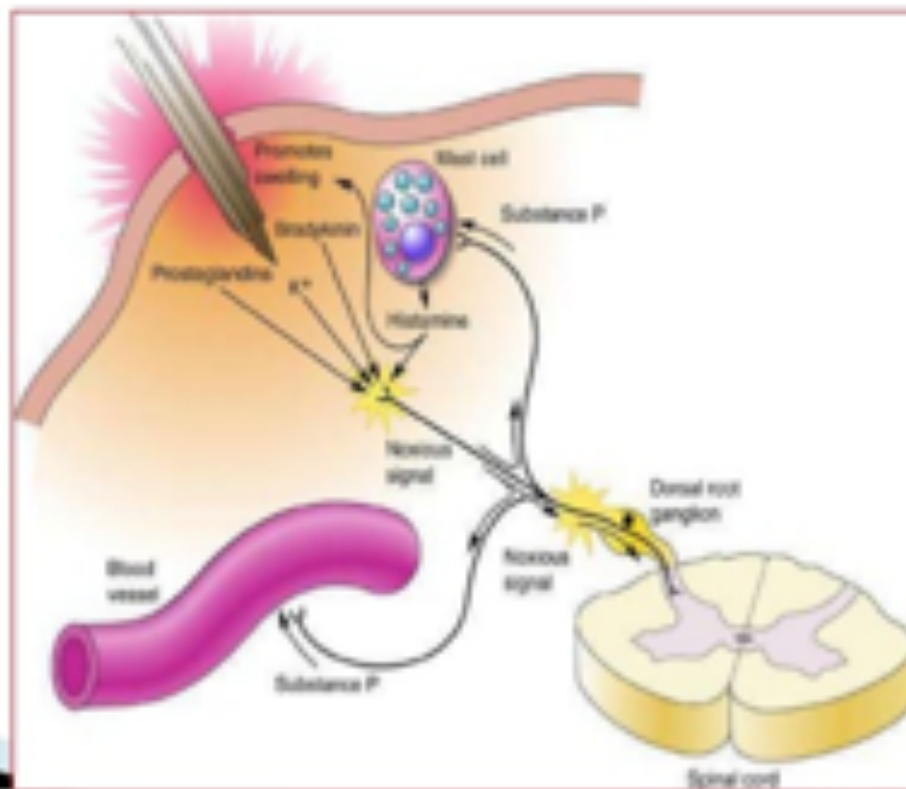

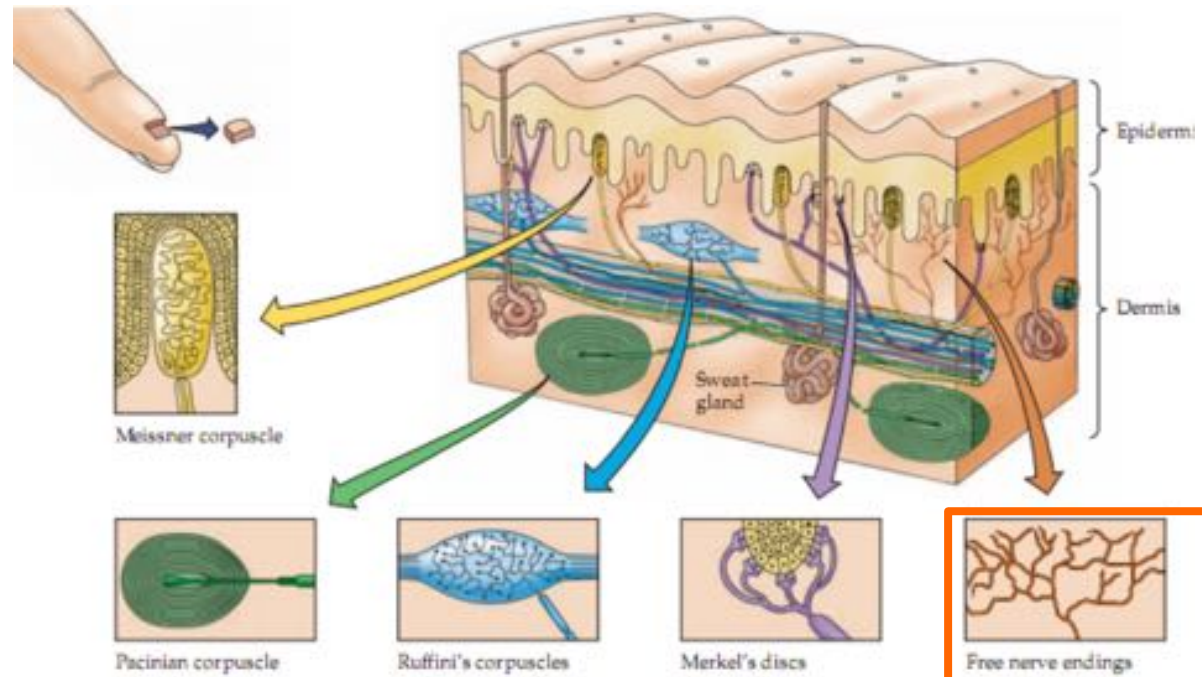
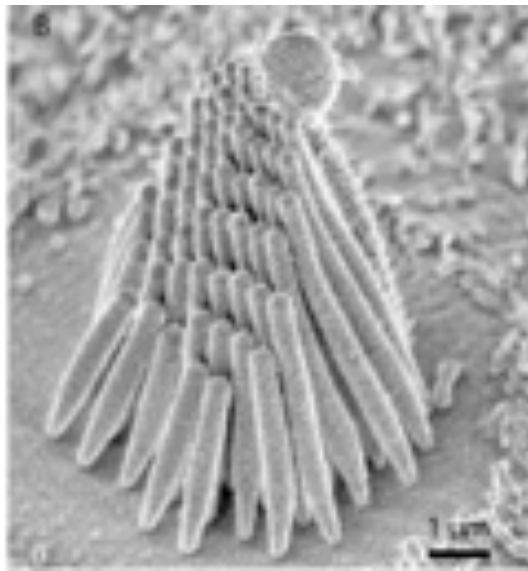

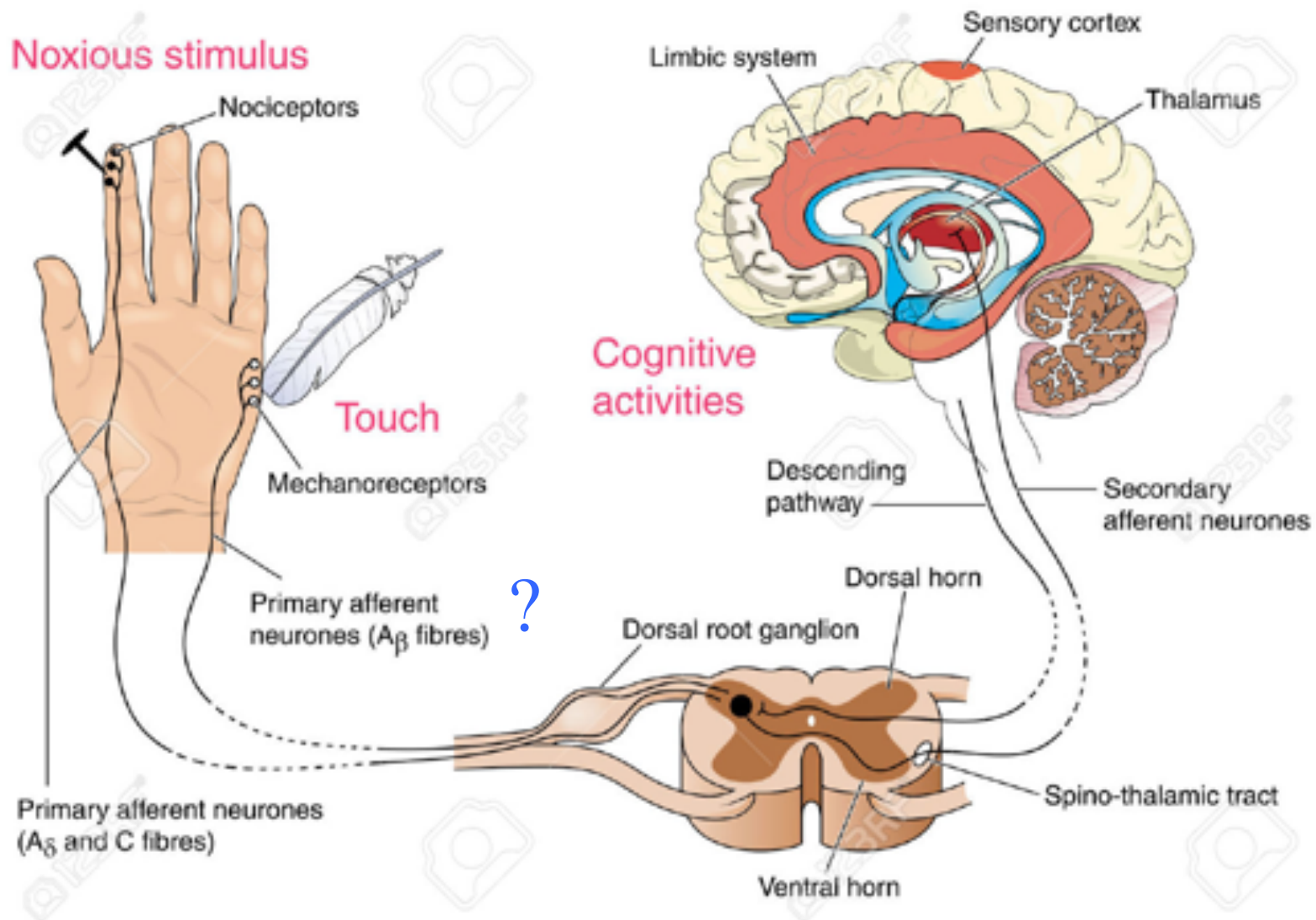

apologies to artist for no credit :(

pain



The only pain supportable pain... is the pain of others

Oscar Wilde

Pain is an alarm signal

Congenital absence of pain



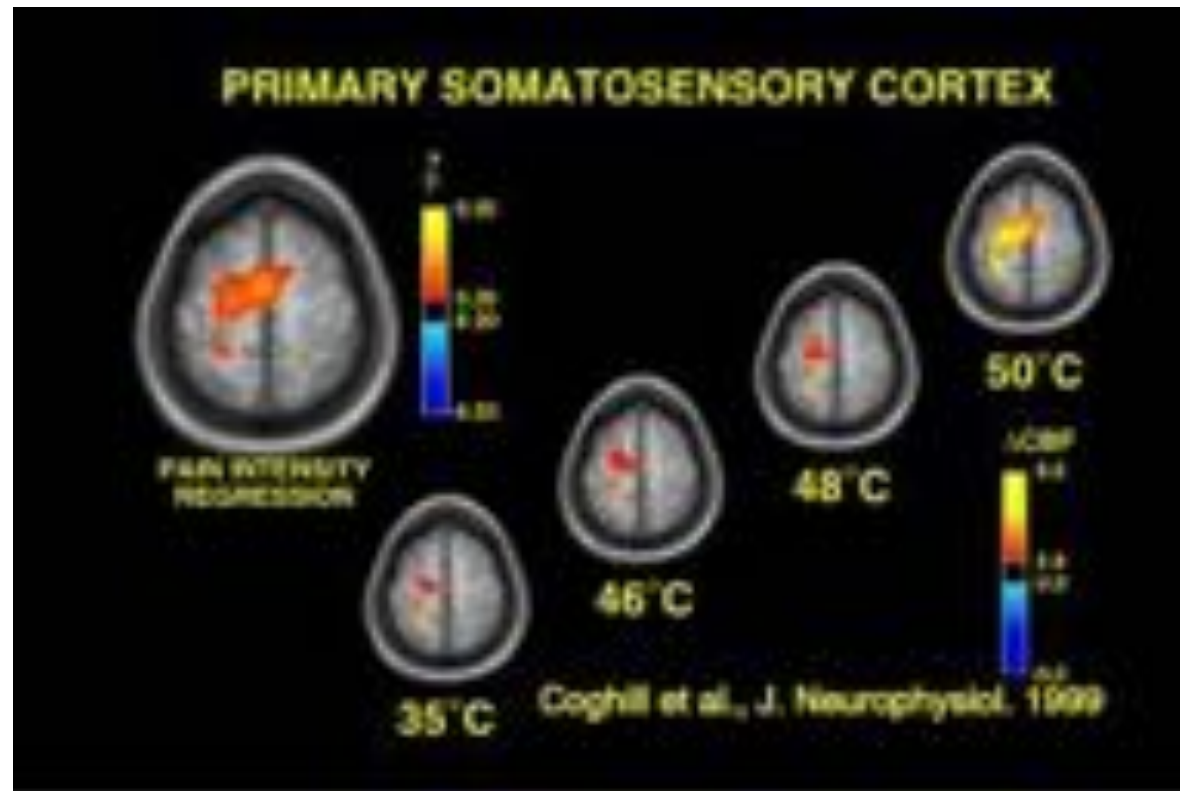

Pain intensity-related activation of the primary somatosensory cortex. Multiple regression analyses of PET scans of cerebral blood flow reveal that the contralateral primary somatosensory cortex (SI) exhibits activation which is significantly related to the perceived intensity of noxious thermal stimuli (upper left image). Activation differences are somatotopically appropriate and are located in a zone consistent with the upper arm.

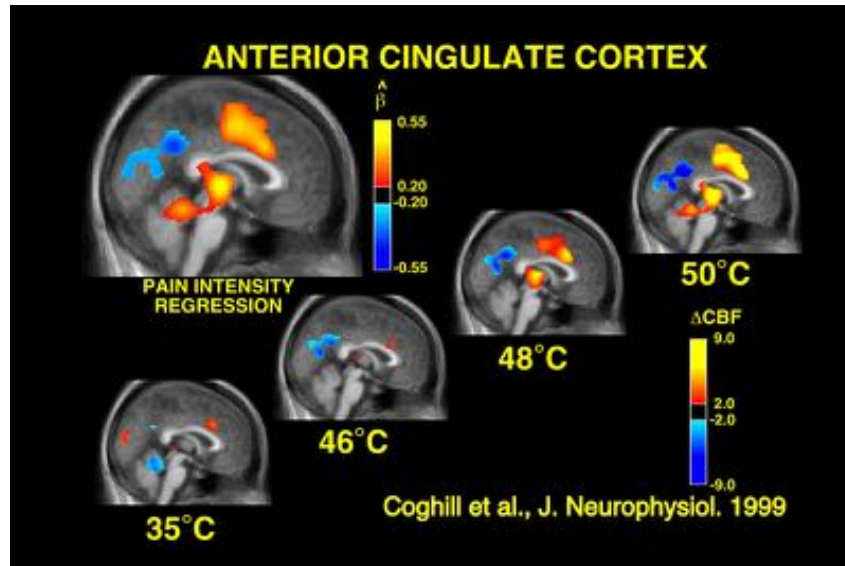

Pain intensity-related activation of the anterior cingulate cortex. Multiple regression analyses of PET scans of cerebral blood flow reveal that multiple regions of the anterior cingulate cortex (ACC) exhibit activation which is significantly related to the perceived intensity of noxious thermal stimuli (upper left image). Numerous lines of evidence indicate that the anterior cingulate cortex is involved in the processing of affective components of pain. However, activation of this region in a manner related to a sensory-discriminative feature of pain (ie pain intensity) suggests a broader role in the processing of pain

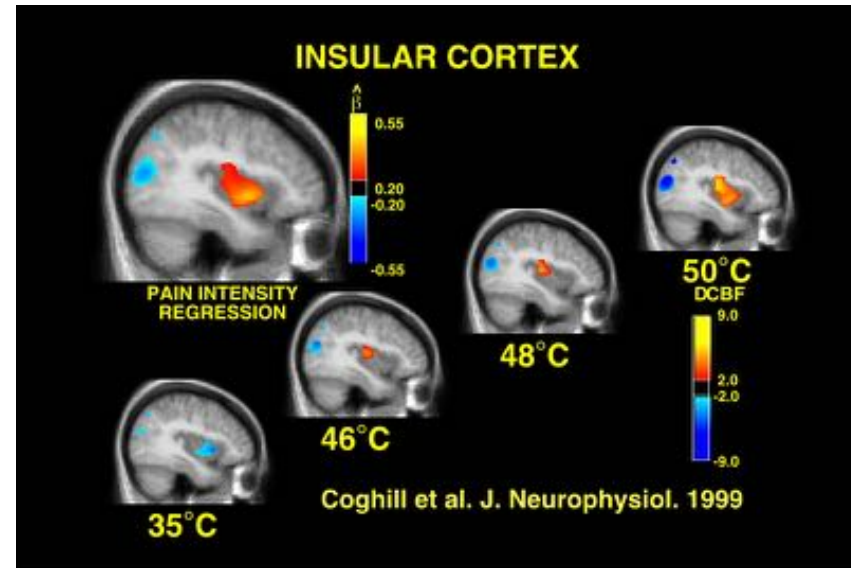

Pain intensity-related activation of the insular cortex. Multiple regression analyses of PET scans of cerebral blood flow reveal that the insular cortex exhibits activation which is significantly related to the perceived intensity of noxious thermal stimuli (upper left image). Much like the anterior cingulate cortex, this brain region has significant connections with both the prefrontal cortex and amygdala, and may play an important role in imparting meaning to the experience of pain

Primary SS cortex and ACC+Ins cortex activated in proportion to pain.

So why discriminative/affective distinction?
Largely based on lesion effects.

activation of ACC and INS correlated with affective dimension of pain

Anti-pain substances reduce pain (of course) but also activation of ACC - INS

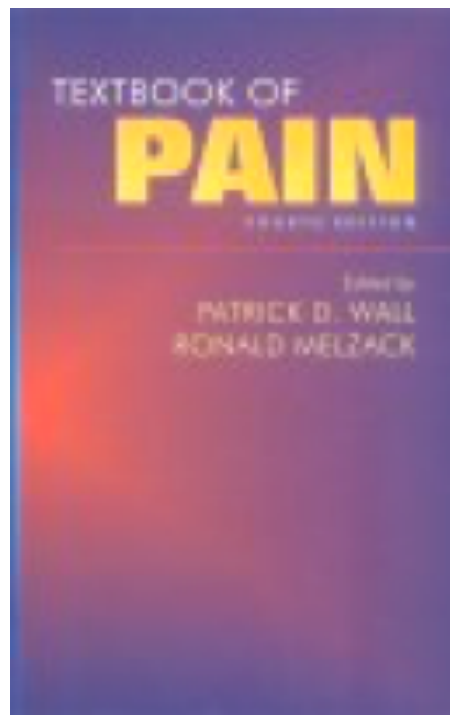

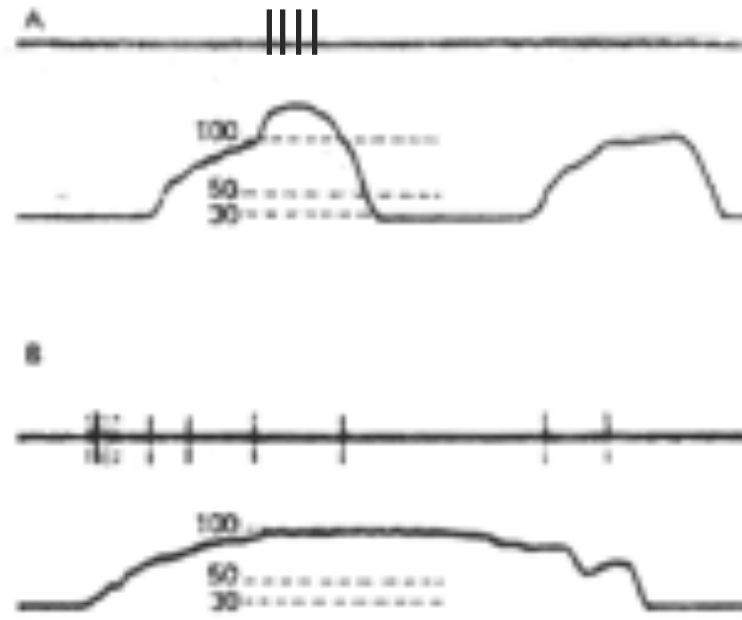

Relation between receptors and pain not so simple as shown here!!



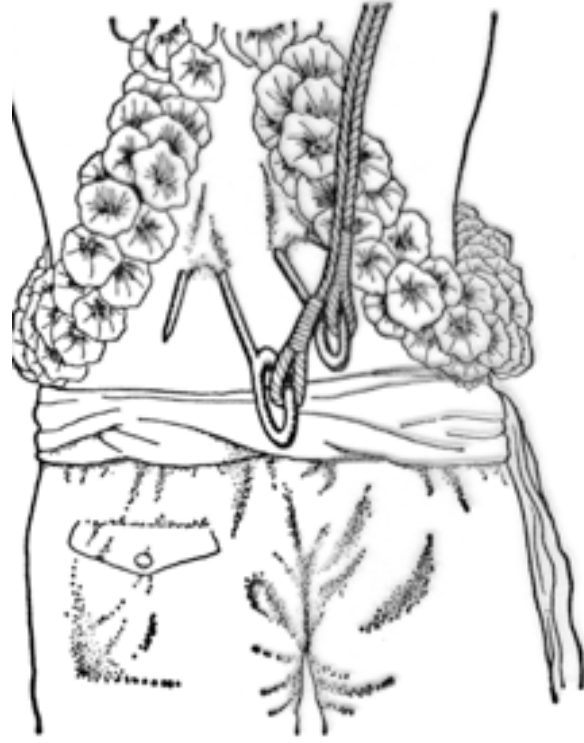

Nociceptors

- ▶ Nociceptors are special receptors that respond only to **noxious** stimuli and generate nerve impulses which the brain interprets as “pain”
- ▶ Free nerve endings
- ▶ Tissue damage

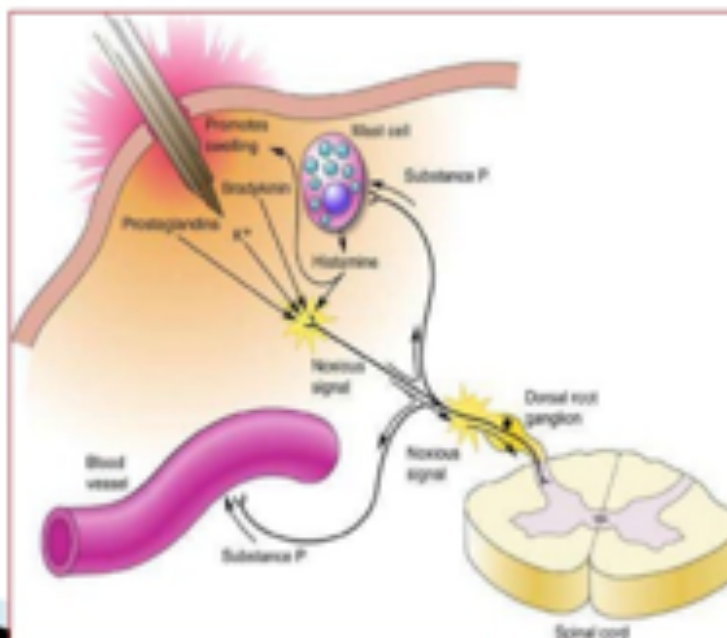

Although “pain pathways” from the skin have been identified, it is incorrect to suppose that a specified quantity of nociceptor impulses travels in an uninterrupted stream to cerebral cortex to produce a proportional quantity of pain.

Rather, a given level of nociceptor activation can produce dramatically different subjective experiences under different conditions. A soldier charging into battle may not even notice injuries that would, under other circumstances, produce exceptional pain.

At the opposite end of the spectrum, a chronic pain syndrome can exist even without abnormal activity in skin nociceptors.

It is the central processing of nociceptor signals, not their mere presence, that gives rise to the sensory and affective experience.

Understanding pain thus requires understanding how the stream of impulses arriving from the nociceptors is processed by the rest of the nervous system. And, as pointed out by Melzack, the subjective experience of pain, more than the experience any other signal originating in a sensory organ, is modulated by social, cultural, and personal factors.

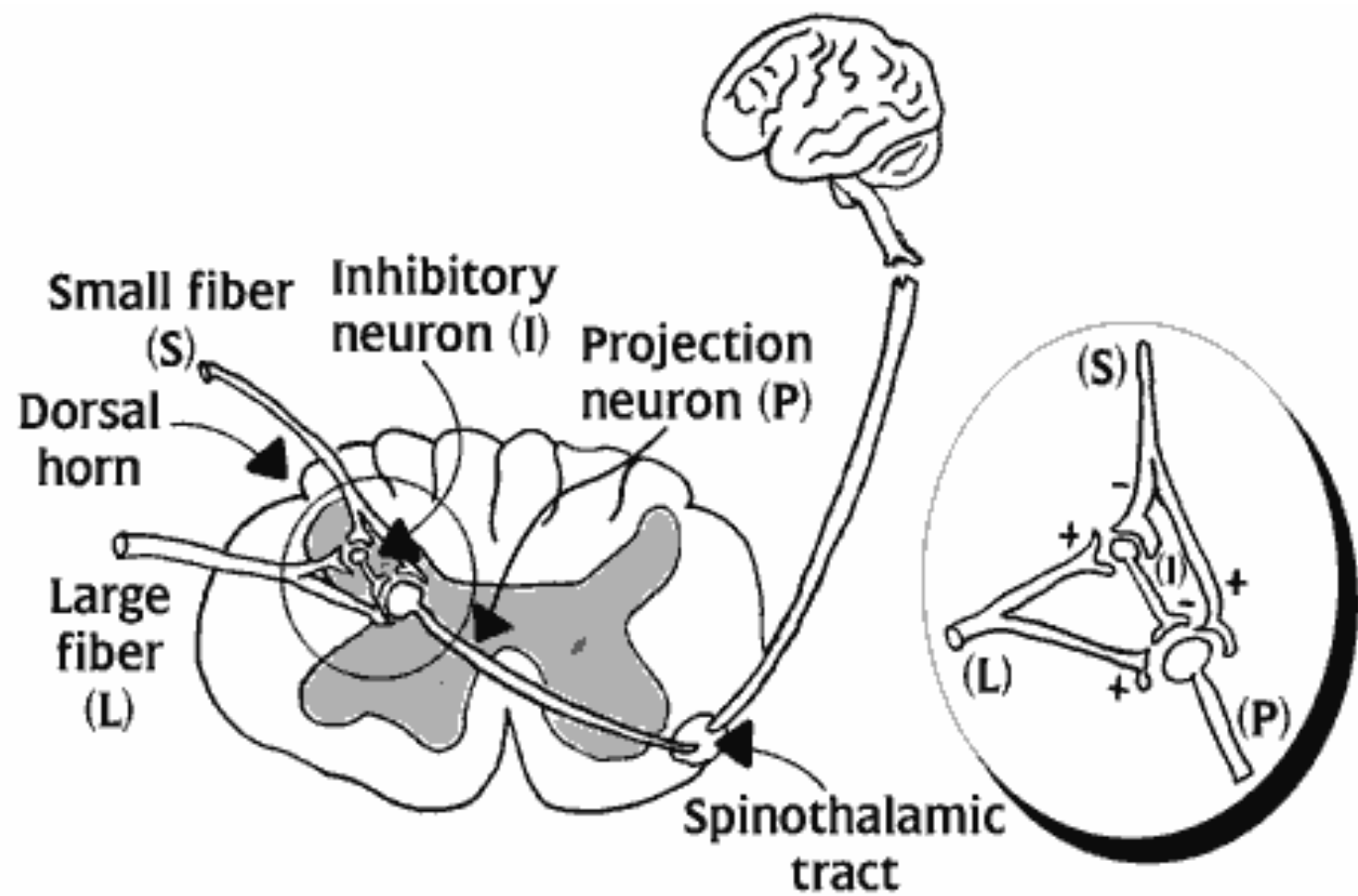

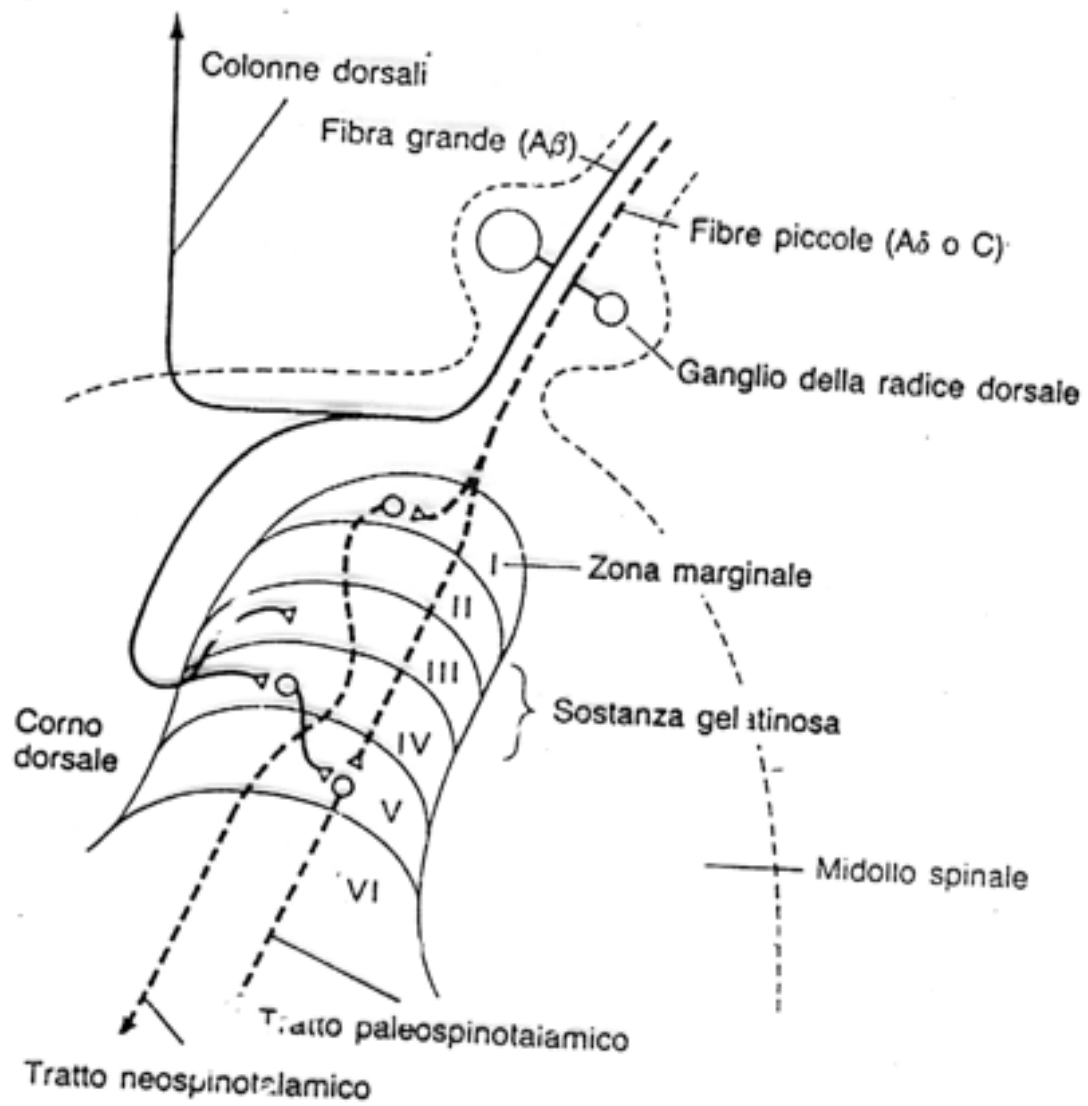

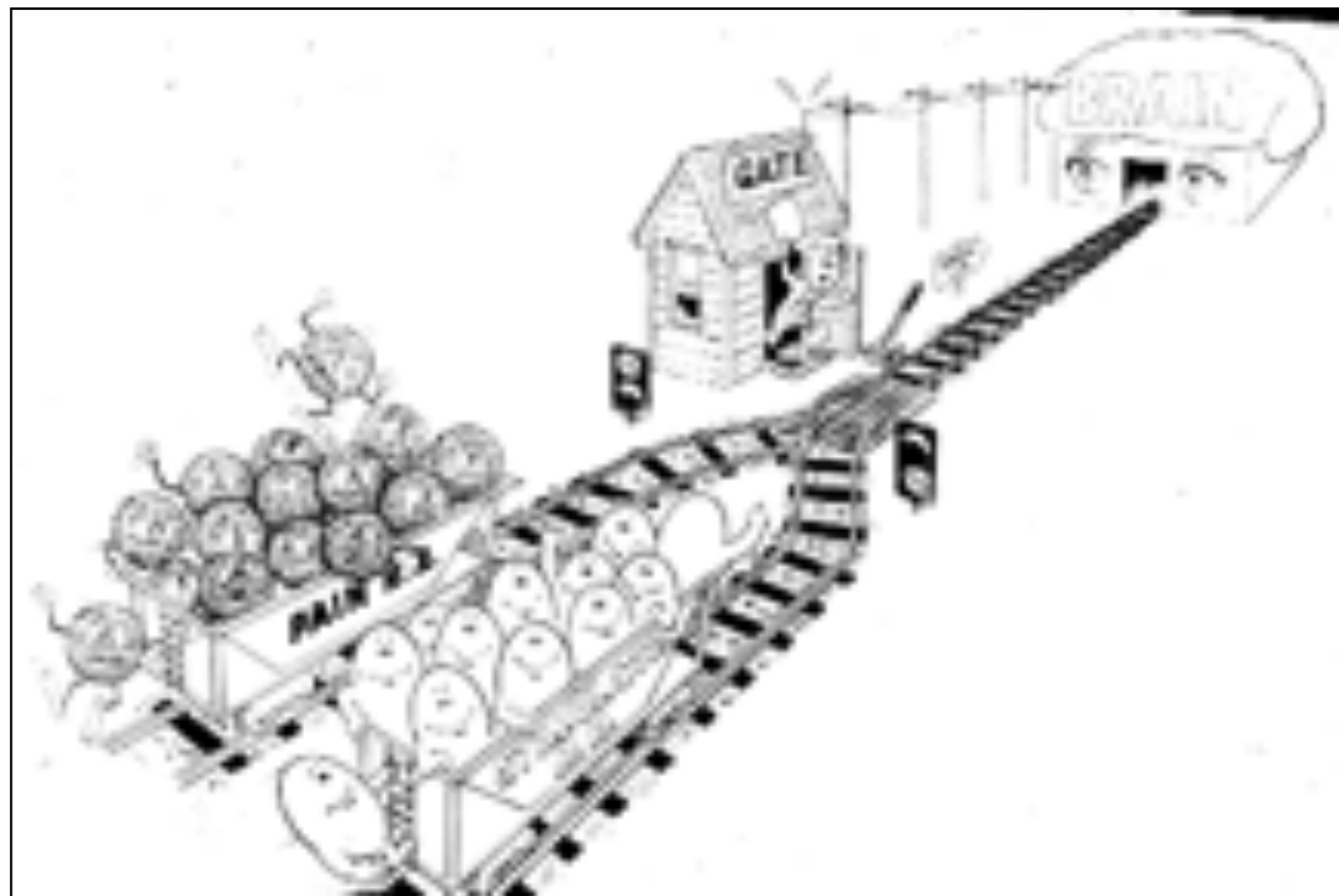

pain

GATE CONTROL

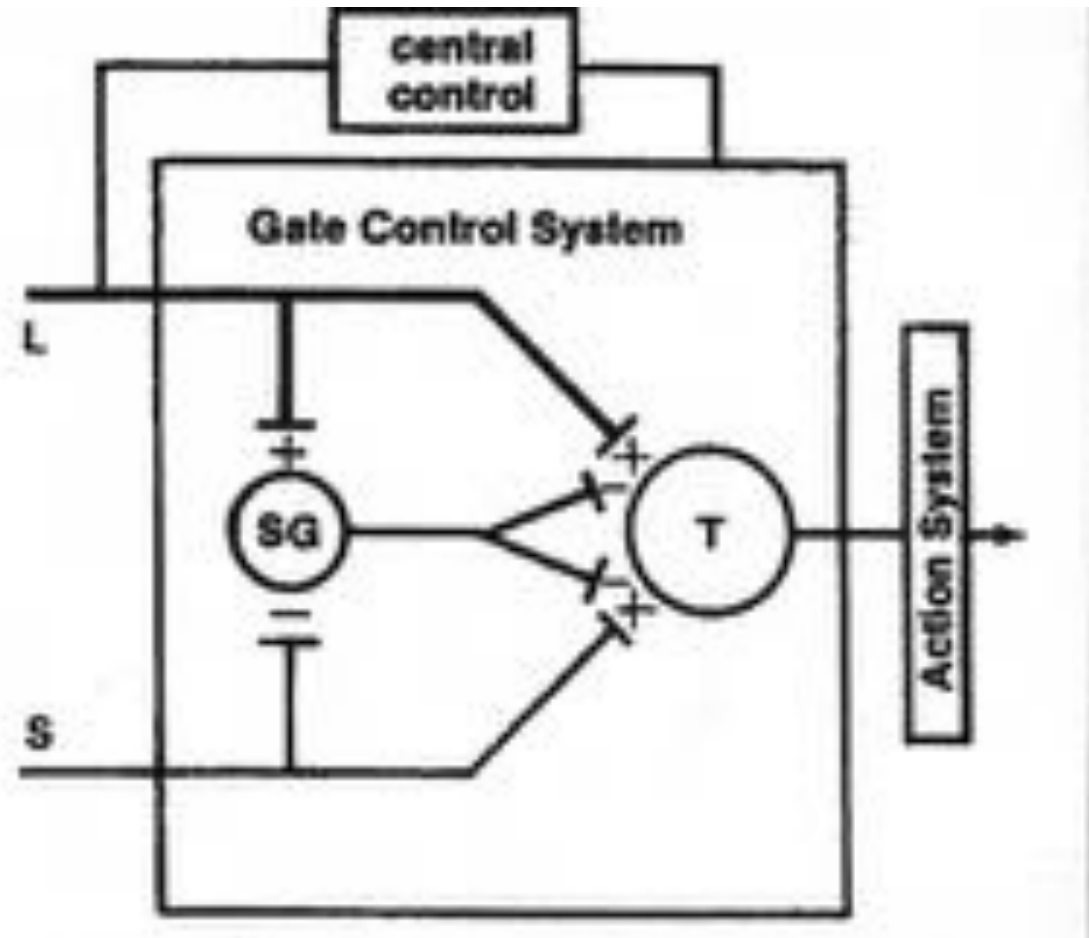

Pain modulation

personal history

culture

stress

suggestion (placebo)

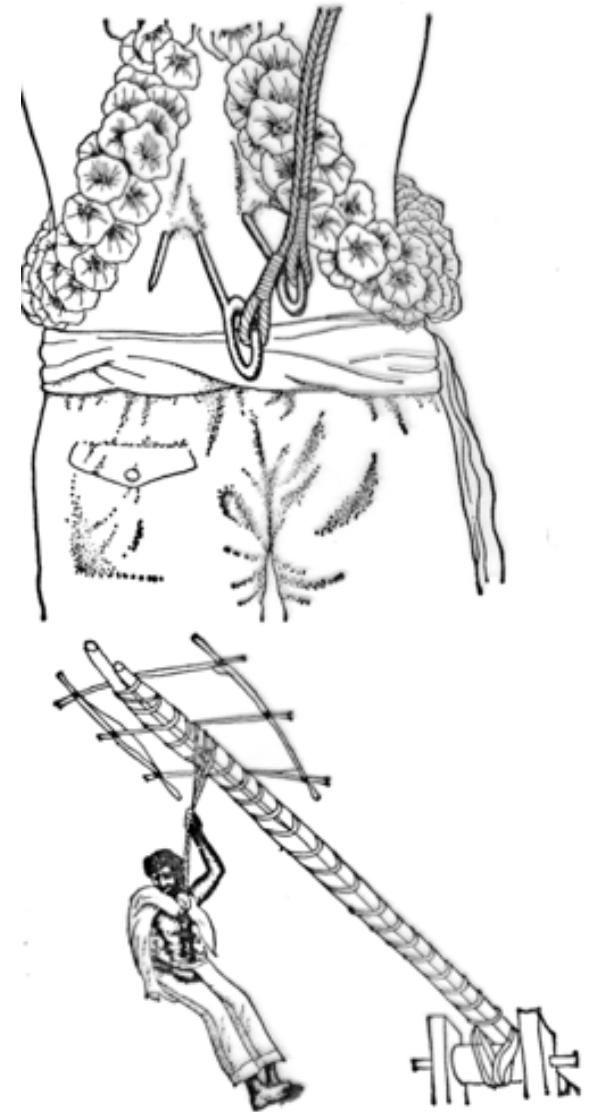

Can we control the operation of the endogenous pain modulation system and thereby suppress chronic pain that has outlived its usefulness as an alarm bell? Can we reduce dependence on addictive painkillers?

Recent research shows that placebo treatment—the suggestion of pain reduction without medication or functional treatment—can effectively reduce even a postoperative pain experience.

- PLACEBO effectiveness depends on the degree to which the patient is persuaded that the treatment will work; for instance, placebo treatments that appear costly by their packaging are more effective than placebo treatments that appear inexpensive.
- The dependence of placebo treatment on expected efficacy parallels the dependence of an actual painkiller treatment on the expected result – subjects experience more opioid-induced pain suppression when told to expect significant relief.
- Placebo functions by activating opioid receptors: placebo-evoked pain suppression is eliminated by blocking m-opioid receptors.

- Functional magnetic resonance imaging experiments show that the effectiveness of suggestion in reducing subjective pain is positively correlated with the degree of suppression of activity in anterior cingulate and insular cortex.
- Thus, placebo acts directly on the networks that normally generate the unpleasant experience of pain. A fascinating finding is that the expectation of a *negative* outcome can cause an intensification of pain sensations and can cause even a normally innocuous stimulus to be felt as painful.
- This **nocebo** effect occurs by driving the endogenous opioidergic system in the opposite direction of the placebo effect.

Just as the patient's expectation of pain reduction can lead to an increased likelihood of that outcome, so can the expectation of a treatment side effect lead to the appearance of that side effect:

- Subjects were given a placebo cream to combat an itchy rash on the arm, but the placebo cream was packaged either to look like an expensive brand or else a cheaper generic product.
- They were told that the cream could cause increased pain sensitivity as a side effect. After application of the cream, subjects received a heating probe on the arm and were asked to quantify the pain.
- Subjects who applied the expensive-looking cream reported twice as much pain, that is, twice as strong a side effect. The increased pain sensitivity was accompanied by increased activation in the anterior cingulate cortex.
- The fact that expected side effects are actually experienced by patients, and that the strength of the side effect is correlated with the expected strength of real treatment, creates a dilemma for the medical professions; patients need to know about the possible occurrence of undesirable effects from a treatment, but knowledge of those undesirable side effects makes them more probable.

Placebo effect (prof. Fabrizio Benedetti, Univ. Torino)

1. Pain suppression not from active ingredients but from expectations.
2. Patient must expect and believe.
3. Patient must know that they are receiving treatment
4. No effect if unaware (communication and visualization)